

# LD81M



Miniature LED spotlight with Mounting Systems

Data sheet - Page 1





 Project: Jimmy Choo, London Product: LD81M  
 Design: Illumination Works

The LD81M is a smaller, more discreet version of the LD81, using the same LED, optics and mounting methods. Maximum output is 1.2W compared to 2.4W in the LD81. Each mounting method is custom made to each projects requirements, allowing the designer to tailor the lighting layout for each display. The best method of specification for these spotlights and mounting systems is to send us a sketch of what is required. This can then be discussed and we will produce a project specification and quote.

## Key Features

- Smaller version of the LD81
- Utilizes the latest LED technology with a typical CRI of 93 in warm white
- Broad range of uses including display, picture and sign lighting
- Compact design with high output
- Knuckle joint allows great flexibility in adjustment
- Custom made fixing solutions to suit exact specified dimensions
- Precise beam control with a range of optics
- Available with Switch, 0-10V, DMX, Dali or Mains dimmable drivers

## Specification

Applications	  
Beam Angles	12°, 34°, 55°, 12° x 36°
LED type	1 x C1 Engine with NICHIA LED
Colour temperature	2200K / 2700K / 3000K / 4000K / 5000K
Drive Current (mA)	350
LED power* (W)	1.2W
CRI (typical)	93
Forward voltage (V) <sub>100</sub>	3.0V
Delivered lumens** (L <sub>100</sub> )	113
Lumens per circuit watt	95
LED lifetime	L90B5 at 90,000hrs
Materials	Anodised aluminium body
Wiring	Comes pre-wired with 2 core 120mm lead, can be specified with up to 10m at extra cost
IP rating	IP40

\*LED wattage includes losses associated with using an 85% efficient driver

\*\* Lumen output data applies to all colour temperatures.

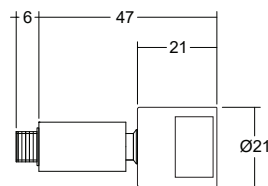

# LD81M



Miniature LED spotlight with Mounting Systems

Data sheet - Page 2

## Mounting Options and Dimensions

**Stem Mounting Methods** - This 2 part aluminium profile has been designed as a slight oval and is counterbored where the knuckles attach which gives a slim look and neat detail at the junction. The best method of specification is to send us a sketch of what is required, this can then be discussed and a project quote created. 4 mounting methods are available and each is custom made to the specification.

### /M1

Method 1 - for fixing to the base of a cabinet, with cables exiting from the M8 all-thread stud. Specify stem length, number of spotlights and spacing.

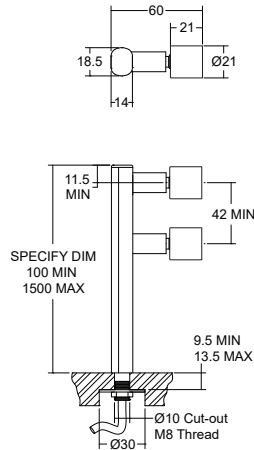

### /M1D

Method 1 Double - this uses the same fixing method as /M1 with the addition of opposing light sources. Specify stem length, number of spotlights and spacing.

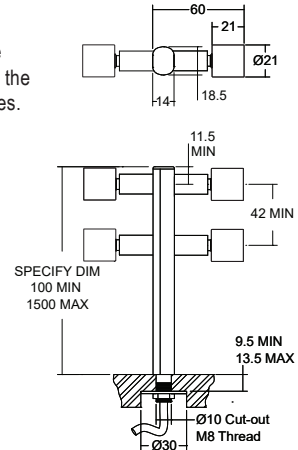

### /M2

Method 2 - surface mounted option with cable exit at the back. Specify stem length, number of spotlights and spacing.

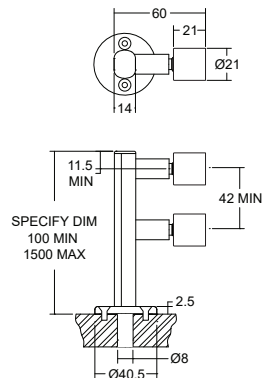

### /M2D

Method 2 Double - this uses the same surface mounting method as /M2 with the addition of opposing light sources. Specify stem length, number of spotlights and spacing.

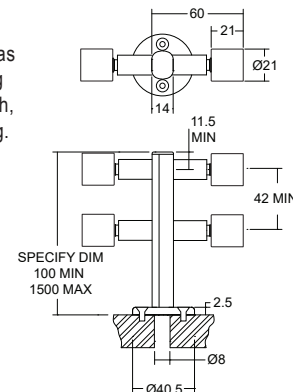

### /M3

Method 3 - stem is fixed at the bottom with a surface mount base and screws. An M8 thread and nut is used to fix at the top. Specify stem length, number of spotlights and spacing.

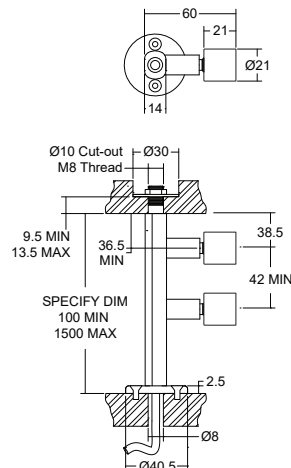

### /M3D

Method 3 Double - this uses the same mounting method as /M3 with the addition of opposing light sources. Specify stem length, number of spotlights and spacing.

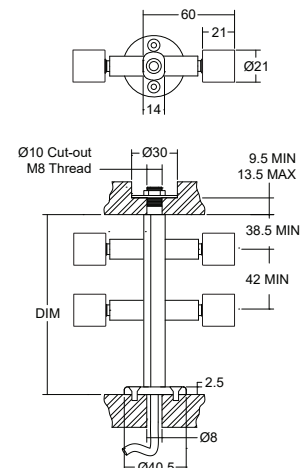

# LD81M



Miniature LED spotlight with Mounting Systems

Data sheet - Page 3

## /M4

Method 4 - goal post method. Specify stem and leg support length, height, LED spacing and number of spots.

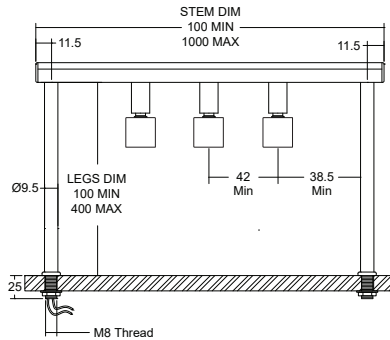

## Alternative Mounting Methods

### /E1313

Aluminium U channel can be flush mounted into a routed groove into the side of cabinets which makes a very neat detail. All the wiring can be done at the manufacturing stage speeding up installation.

Specify length, number of spotlights and spacing.

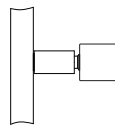
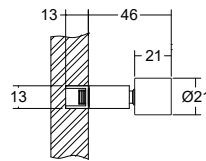

### /PL1

Single swivel mounting plate is very useful for mounting individual spotlights neatly into the sides, top or base of cabinets.

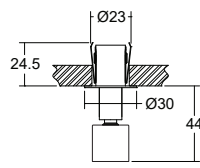

## Photometrics

Photometric files are included in the design pack which can be downloaded from the LD81M product page on the website.

## Size Comparison

Size comparison between the LD81M and the LD81



## Order Codes and Options

Product code	LED colour	Lens angle	Finish	Mounting method	Length
LD81M-C1-350					

Example: LD81M-C1-350 / LW30 / MB / Silver / M1 / 500mm

### Product codes with output options

1.2W LED at 350mA

LD81M-C1-350

### LED colour options

Super Warm White (2200K)  
 Extra Warm White (2700K)  
 Warm White (3000K)  
 White (4000K) - on request  
 Cool White (5000K)

### Suffix

/LW22  
 /LW27  
 /LW30  
 /LW40  
 /LW50

\*Other LED colour temperatures are available. Please speak to a member of our sales team.

### Beam / lens angle options

12° narrow spot  
 34° medium  
 55° Wide  
 12° x 36° oval beam

/NB  
 /MB  
 /WB  
 /OB

### Finish options

Paint finish silver / black / white (RAL 9016) / antique bronze / satin antique brass / satin brass / RAL finish

### Mounting method

Method 1  
 Method 1 Double  
 Method 2  
 Method 2 Double  
 Method 3  
 Method 3 Double  
 Method 4  
 Aluminium U channel  
 Single swivel mounting plate

M1  
 M1D  
 M2  
 M2D  
 M3  
 M3D  
 M4  
 E1313  
 PL1

### Use with 350mA constant current LED drivers

We have a wide range of dimmable LED drivers, 0-10V, DMX, DALI and Mains dimmable. Please see the downloads section on our website:

To run 1-14 LD81M-C1-350 in series use a TXDEL350D (0-10V dimmable)

To run 1-14 LD81M-C1-500 in series use a TXDEL500D (0-10V dimmable)

To run 1-14 LD81M-C1-700 in series use a TXDEL700D (0-10V dimmable)