

## LD34MI

### HIGH-POWER IN-GROUND MAINS-IN LED LINEAR WALL GRAZER

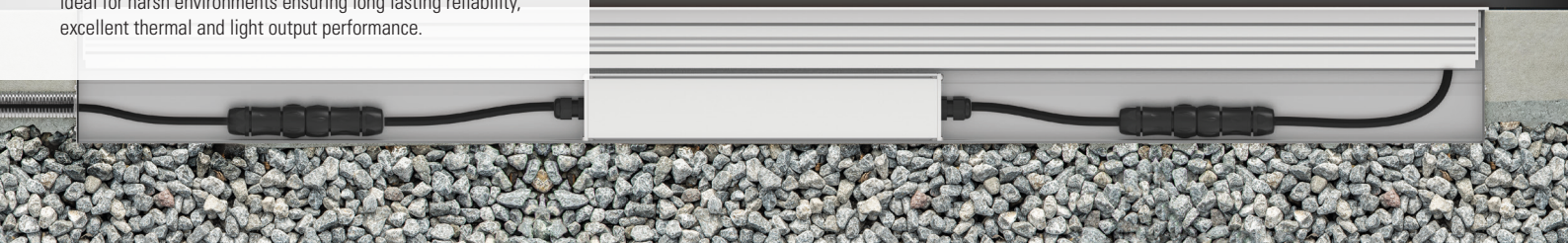

The LD34MI is a low glare, shallow recessed, in-ground linear wall grazer. With the addition of a plug and play mains-in system, the product can be installed quickly and easily with no requirement for remote driver locations. The luminaire features a fixed 2.5° tilt, integral glare control options, as well as individual cowls over each LED to ensure low glare from the viewer's perspective. Multiple colour temperatures and beam angles are available as well as accessories including an optional frosted diffusion filter, to illuminate even the lowest parts of the wall. A variety of cable lengths and types are available to suit almost any installation requirements. With 5 set lengths and a compact design, this high-power solution is ideal for harsh environments ensuring long lasting reliability, excellent thermal and light output performance.



## KEY FEATURES



- > Plug and play mains-in system with pre-wired IP67, 2-pole or 5-pole connectors for switched and dimmable applications, delivering up to 3263lm/m
- > Single mains cable feeds a full or multiple runs (when used with interconnection cables)
- > Toughened glass top to ensure longevity and resilience against external impact. IK08
- > Available lengths include 450mm, 600mm, 750mm, 1050mm and 1350mm
- > 50mm spacing maintained across in-line lengths, ensuring no dark spots
- > Compact design with only a 115mm recess depth including concrete housing
- > Manufactured from aluminium and anodised to a thickness of 25 microns.
- > LED fixed at a 2.5° tilt with a wide choice of beam angles and superb wall grazing capabilities using the 15° x 60° extra oval beam
- > Range of glare control accessories to ensure low glare from all directions
- > Optional frosted diffusion filter to illuminate lower parts of the wall
- > First fix concrete housing with multiple cable options available
- > Switched, 0-10V and DALI dimmable drivers available

## DIMENSIONS

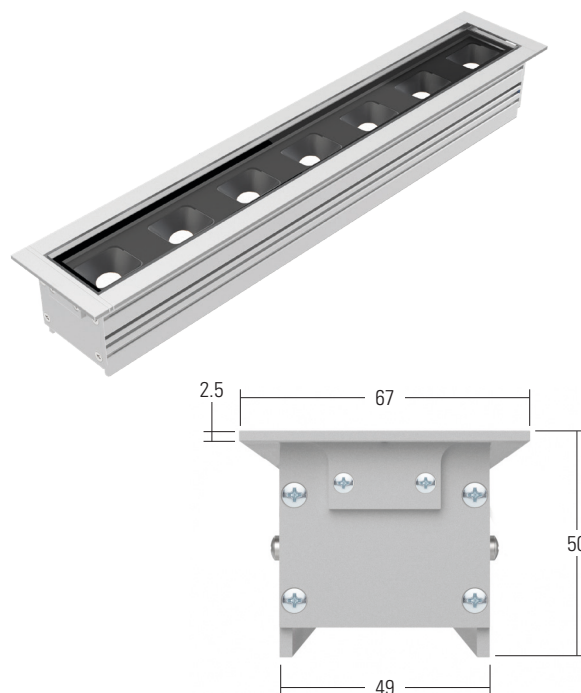
Dimensions in mm



## WHITE LED ENGINE SPECIFICATION

Engine	 Linear C1	
Beam angles	12°, 31°, 48°, 12° x 36°, 15° x 60°	
LED manufacturer	NICHIA	
Colour temperature	2200K / 2700K / 3000K / 4000K / 5000K	
Current	350mA	700mA
LED power (Max)**	1.7W	2.4W
Forward voltage (V <sub>100</sub> )	3.2V	3.4V
Delivered lumens (L <sub>100</sub> )* per metre		
50mm spacing	2420	3263
75mm spacing	1609	2170
Lumens per circuit watt	71	68
CRI (Typ)	93	
Colour consistency	2SCDM	
Peak intensity	18,058 cd	
LED lumens (per LED)	206lm	
LOR	0.79	
TM30	RF93	RG99
LED lifetime	L90B5 at 90,000hrs	
Applications		

This data is based on an LD34-C1-700-LW30-NB

\*Lumen output data applies to all colour temperatures

\*\*indicates the nominal power for the LED run at that particular current and includes losses associated with using an 85% efficient driver

## MECHANICAL

Ambient temperature	-20° to 45° (500mA) or -20° to 35° (700mA)
Glass	Low iron glass, 8mm thick
Materials	Silver anodised aluminium body & end caps, polycarbonate cover and cowls
Weight of product	3.5kg per/m
Static load	1500kg
IP rating	IP67
IK rating	IK08
Wiring	Pre-wired with cable and connector for use with TXIPDEL driver enclosures
Protection class	II

## ENVIRONMENTAL

TM65	Available on request
TM66	2.1

**DIMENSIONS & FIXING OPTIONS**

*Dimensions in mm*

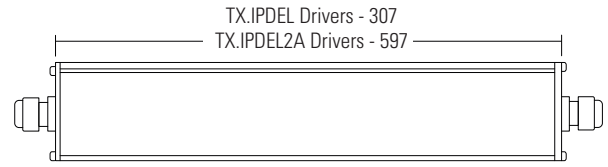
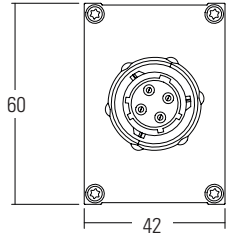
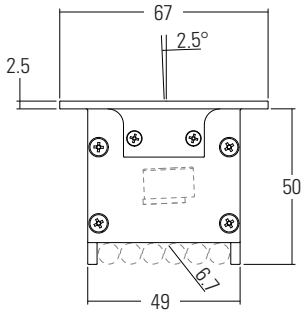

**/SC Spring clips**

For interior applications, spring clips can be used instead of the concrete housing.

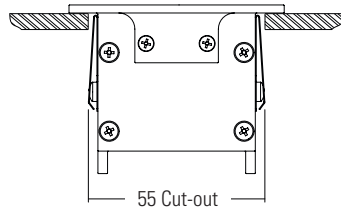
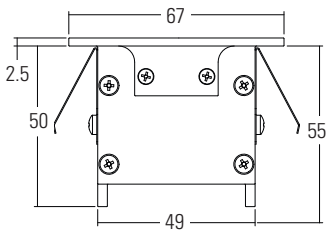

**/CH Concrete housing**

The mains-in system can be specified without a concrete housing, however it is recommended for exterior applications.

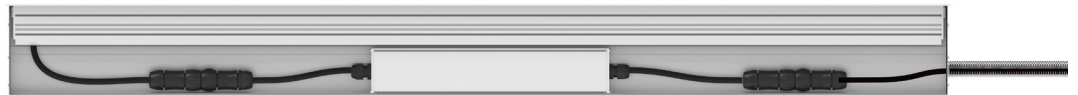
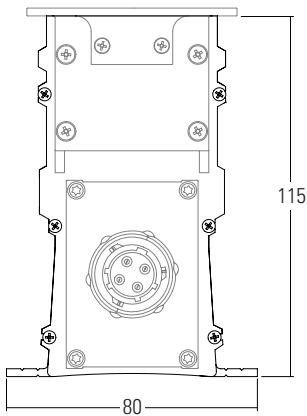

## LD34 COMPONENTS

When using LD34 with a concrete housing, the below diagram shows the components required to assemble both single and in-line installations.

### LD34 Single

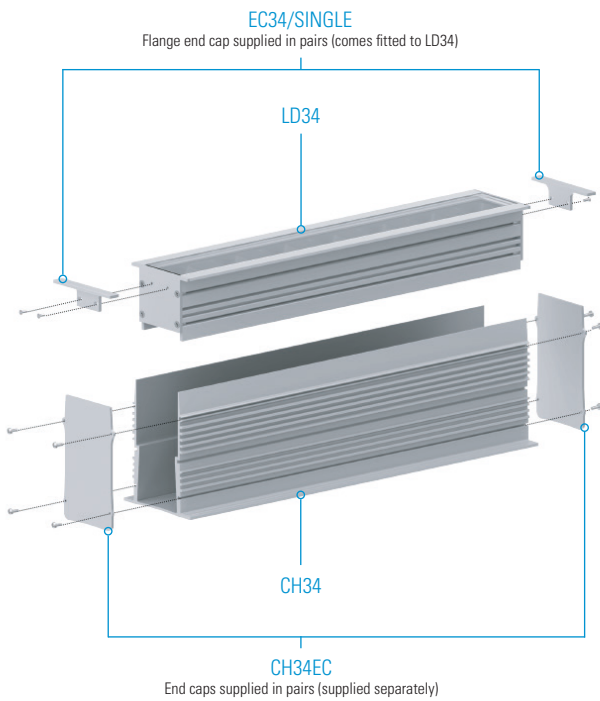

### LD34 In-line

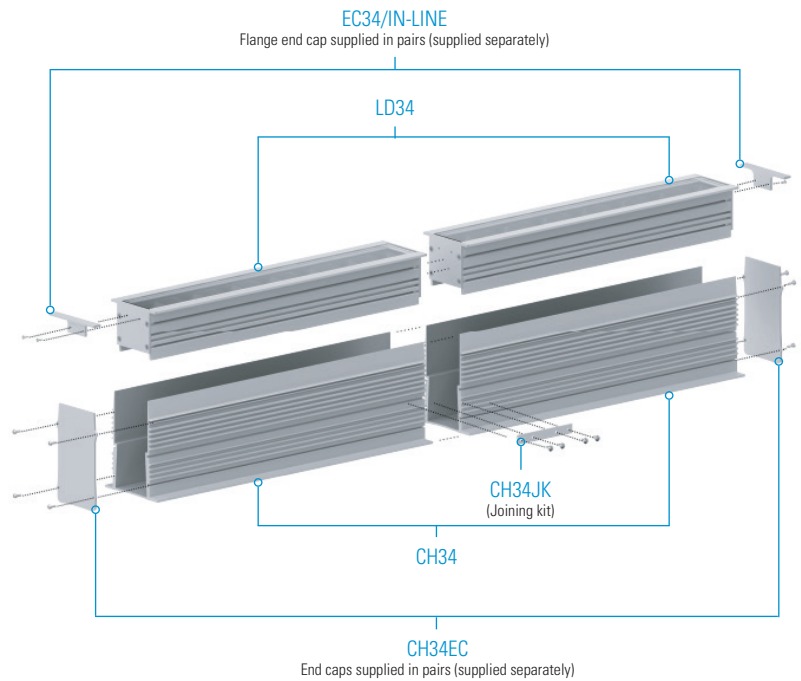

## LENGTH GUIDE

*Dimensions in mm*

The LD34MI is available in 5 set lengths, 450mm, 600mm, 750mm, 1050mm and 1350mm, with LED's spaced at 50mm. Please note an additional 9mm has been added at each end of the run to account for the end cap flange.

### Single length example:

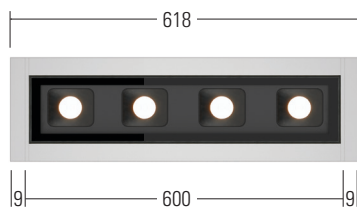

### In-line length example:

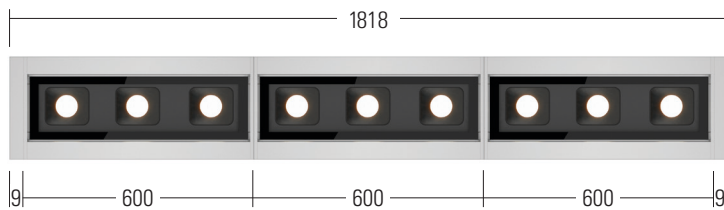

## MAINS-IN SYSTEM COMPONENTS

The components listed below will be required when configuring your LD34MI project.

### TXIPDEL

For installations where multiple single lengths and in-line runs of LD34MI are being used, the TXIPDEL driver enclosure allows through wiring to the next driver in the circuit. Available in 500mA and 700mA with both switched and dimmable options (see driver information on page 11).



### TXIPDEL-E

To be used for a single length or at the end of installations where multiple driver enclosures are in use. Available in 500mA and 700mA with both switched and dimmable options (see driver information on page 11).



### TXAC /\_ST Starter cable

The starter cable carries both the mains power and dimming signal into the first driver enclosure. Available in 2-core for switched and 5-core cables for dimming applications. Available lengths and examples of how to specify each cable are detailed in the codes below, with cable length followed by core type.

Available lengths:

- 3 metres
- 9 metres
- 15 metres
- Custom

Example 2-core: TXAC3/2ST  
Example 5-core: TXAC15/5ST



### TXAC /\_ Interconnection cable

Used to connect between multiple driver enclosures. Available in 2-core for switched and 5 core cables for dimming applications. Available lengths and examples of how to specify each cable are detailed in the codes below, with cable length followed by core type.

Available lengths:

- 450mm
- 600mm
- 900mm
- Custom

Example 2-core: TXAC450/2  
Example 5-core: TXAC900/5



### /CH Concrete Housing

Houses the driver enclosures, cables and LD34MI. Slimline aluminium profile is anodised to 25 microns. The mains-in system can be specified without the concrete housing but the LD34MI will need to be specified with spring clips /SC instead.



## MAINS-IN APPLICATIONS

The mains-in system can be wired 3 ways; single length, multiple single lengths and in-line dependant on the requirements of your project. You will need to specify the correct cable and driver enclosure components based on the method you opt for. Below explains the various scenarios where you may need to use each of the 3 individual methods.

### Single length

For applications where a single length is required. A TXAC/\_/ST starter cable carries both the mains power and dimming signal (where needed) into the TXIPDEL\_\_\_-E driver enclosure to power the length of LD34MI.

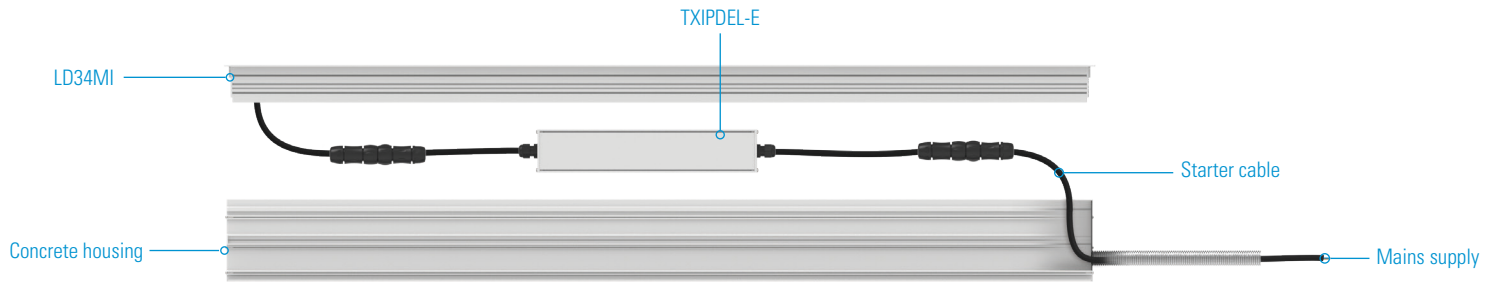

### Multiple single lengths

To be used when multiple lengths of the LD34MI are required but are not placed in-line. TXIPDEL\_\_\_ enclosures should be used for the first and subsequent lengths with the TXAC/\_/ interconnection cables used to link between driver enclosures. The TXIPDEL\_\_\_-E variant should be used as the last driver enclosure in the run.

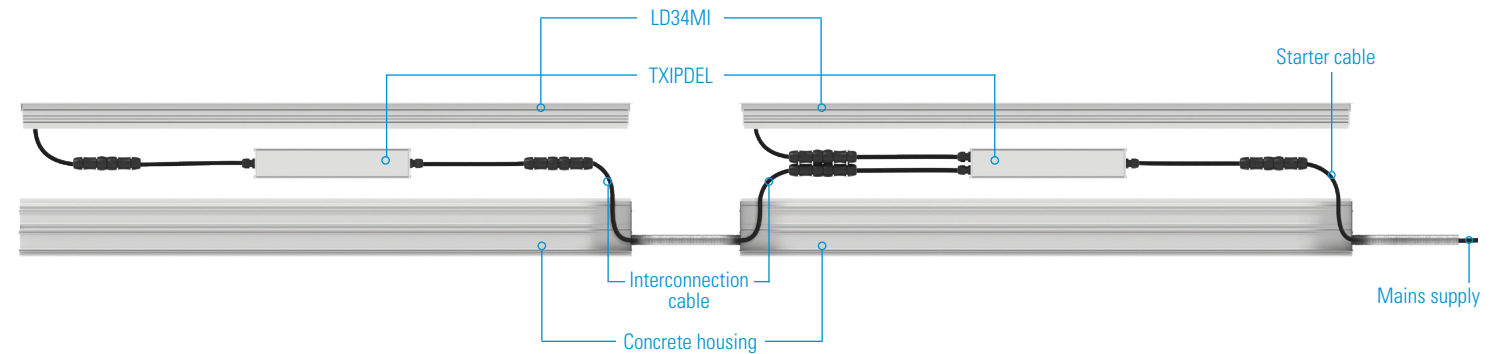

### In-line lengths

When multiple LD34MI's are required in a continuous run. TXIPDEL\_\_\_ enclosures should be used for the first and subsequent lengths with the TXAC/\_/ interconnection cables used to link between driver enclosures. The TXIPDEL\_\_\_-E variant should be used as the last driver enclosure in the run.

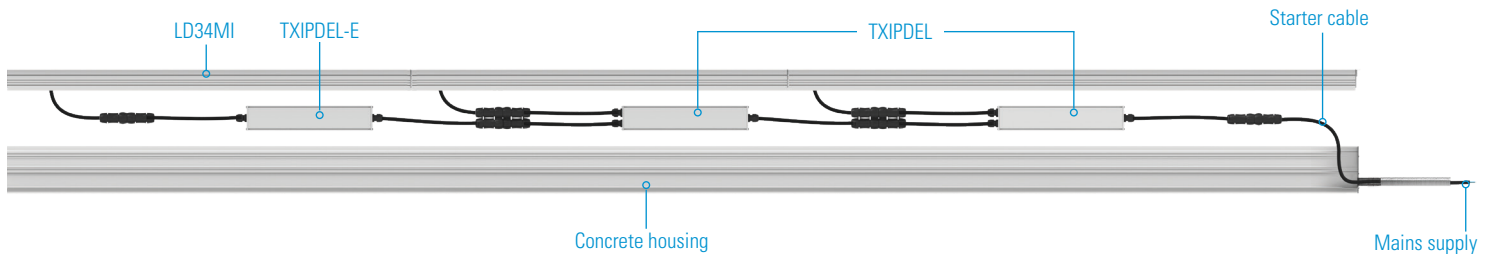

## AVAILABLE FINISHES

LD34MI has been designed for extreme environments therefore only high quality materials and finishes are used to ensure long lasting reliability. All parts are silver anodised to a minimum thickness of 25 microns which offers high protection in all external environments. Though we offer paint finishes, we do not recommend using them in high-traffic areas.



**SILVER ANODISED (SUPPLIED AS STANDARD FINISH)**



**POWDER COAT PAINT FINISH - WHITE (RAL 9016)**



**POWDER COAT PAINT FINISH - BLACK (RAL 9005)**



**POWDER COAT PAINT FINISH - CLASSIC BRONZE (YM262E)**



**POWDER COAT PAINT FINISH - GUNMETAL GREY (RAL 7021)**

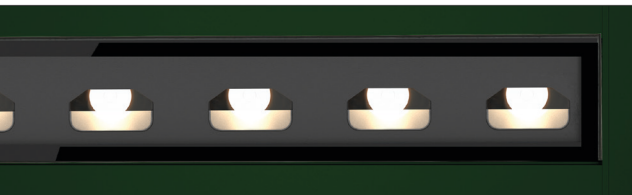

**POWDER COAT PAINT FINISH - TEXTURED FIR GREEN (RAL 6009)**

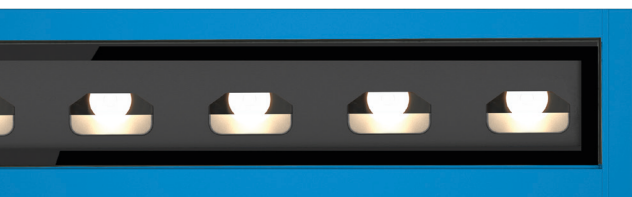

**POWDER COAT PAINT FINISH - RAL**

## LIGHT DISTRIBUTION AND GLARE SHIELD OPTIONS

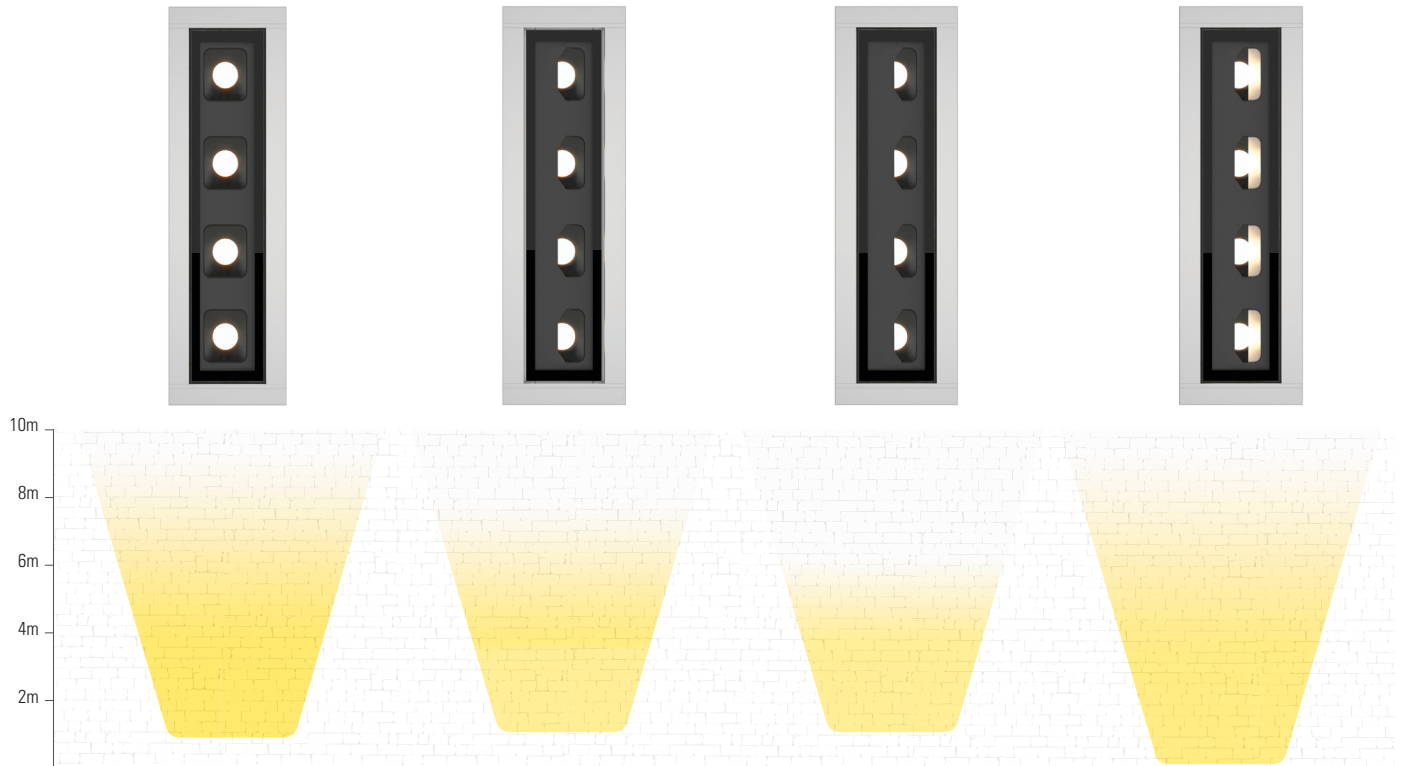

Please note this is a graphical guide to the expected light output, refer to the photometric files for more detailed data.

### LD34MI

No glare shield for maximum lumen output. Deep recessed optic and matt black cowl aids in glare reduction.

### /GS40

Teamed with the 2.5° fixed tilt the 40% glare shield provides glare protection with only a 28% reduction in lumens.

### /GS50

Half glare shield. For an increased cut-off angle and greater glare control.

### /GS40 with /FD

40% glare shield and diffusion film combination. The aperture allows the main punch of the beam to leave the fitting, providing glare protection from one side and moving the start of the beam down to the floor on the other.

## ACCESSORIES

### /GL Anti-glare louvre

LD34MI can be supplied with the glare louvre however the /GS40 is recommended as it provides the same amount of glare protection and delivers a better lit effect on the wall. Please note this is always supplied in a black finish, and is supplied as standard with the louvre positioned to reduce glare when looking at the lit surface.





## INSTALLATION GUIDE

Below is a luminaire positioning guide. Every project and lighting scenario will be different; the table below is to be used as a starting point for any wall wash design. Please use our photometric files to further test the desired effect for your application, which are available on the LD34MI website product page.

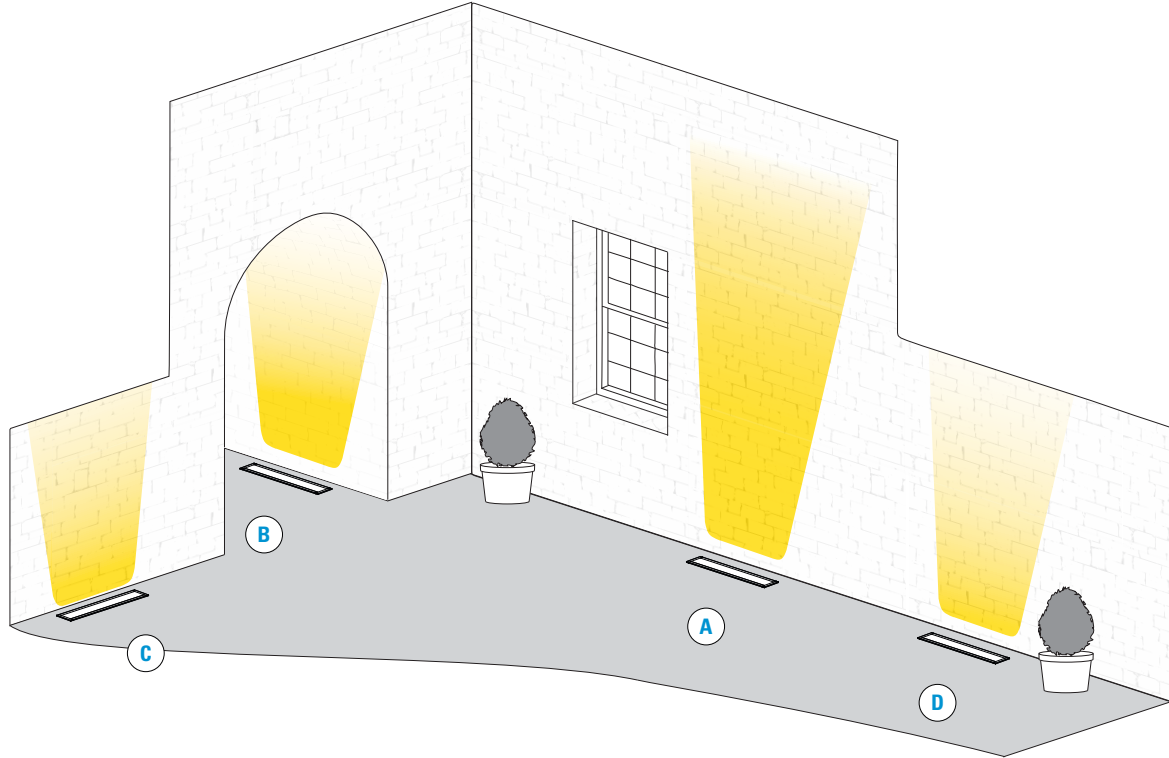

Option	Code	Description	Use
<b>A</b>	LD34MI	Standard LD34MI	The LD34MI can be used when maximum output is required. This option achieves a throw of up to 20m. Even without the presence of a glare shield the cowls over each optic provide a good amount of glare control.
<b>B</b>	/GS50	Glare shield with 50% optic coverage	This option has been designed for use when glare protection is the priority. Narrow corridors and walkways are ideal locations.
<b>C</b>	/GS40/FD	Glare shield with 40% optic coverage and linear diffusion strip.	This option has been designed to lower where the beam starts on the lit surface. This is useful for lighting low walls or when the fitting must be placed further from the lit surface.
<b>D</b>	/GS40	Glare shield with 40% optic coverage	Ideal for use in walkways and arches where glare protection is needed as well as a good punch up the wall.

## BEAM ANGLE OPTIONS

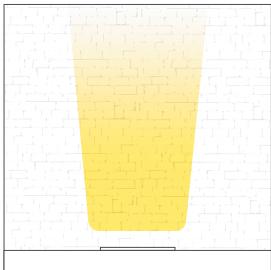

**/NB**  
Narrow Beam  
12°

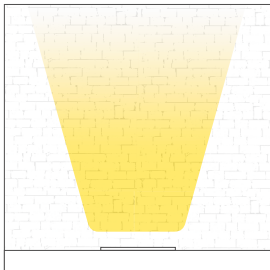

**/MB**  
Medium Beam  
31°

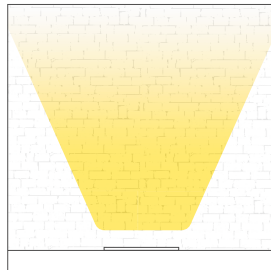

**/WB**  
Wide Beam  
48°

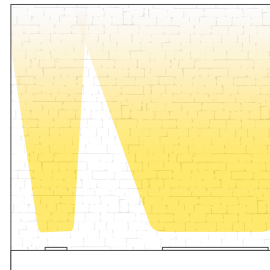

**/OB**  
Oval Beam  
12° x 36°

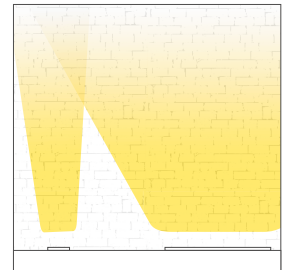

**/EOB**  
Extra Oval Beam  
15° x 60°

PRELIMINARY PRODUCT SPACING GUIDE

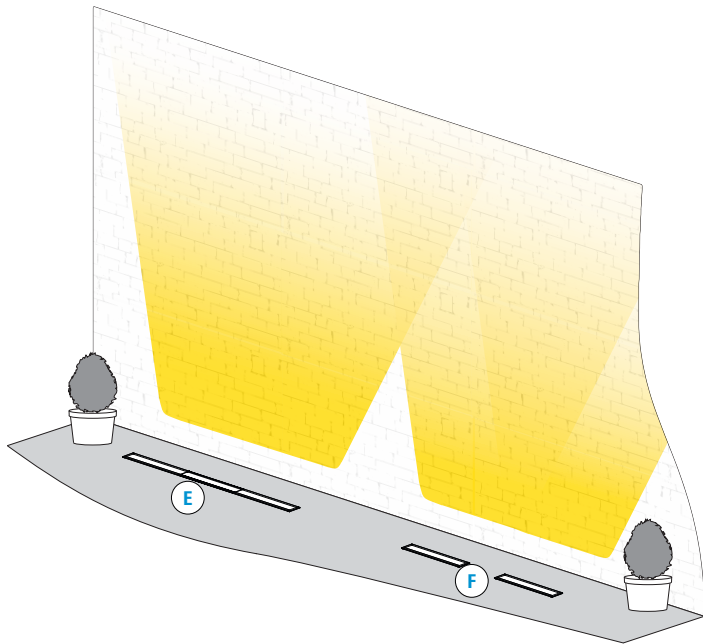

E

LD34MI features the ability to create outstanding continuous wall washing capabilities by seamlessly connecting multiple fittings, while maintaining LED spacing.

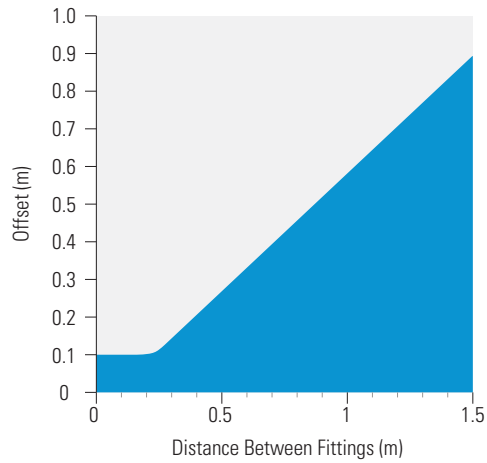

When spacing fittings further apart, the use of /EOB and possibly /FD is recommended depending on the offset and desired lit effect. The graph (left) shows recommended offsets and their corresponding spacings.

Note: These are estimated results please use photometric data to verify.

F

LD34MI can be supplied with the /EOB, featuring a 15° x 60° optic and film combination which allows fittings to be spaced apart from each other but still produce a consistent lit effect.



See graph above for recommended spacing and offset

WIRING QUANTITY PLANNER

LD34MI Specification code:

Driver code guide				
Length	450/600mm		750/1050/1350mm	
Current	500mA	700mA	500mA	700mA
Switched	TXIPDEL500S	TXIPDEL700S	TXIPDEL2A500S	TXIPDEL2A700S
1-10V	TXIPDEL500D	TXIPDEL700D	TXIPDEL2A500D	TXIPDEL2A700D
Dali	TXIPDEL500DALI	TXIPDEL700DALI	TXIPDEL2A500DALI	TXIPDEL2A700DALI

Run Guide

Run one:

Customer reference:

Starter cable (  m ) x

Total requested length

Interconnection cables

LD34MI      450mm x       600mm x       750mm x

                 1050mm       1350mm

                 450mm x       600mm x       900mm x

                 Custom length       m x

Dimming option      Yes       No

Please add a sketch of the requested layout if you feel it will help the quoting of this

Run two:

Customer reference:

Starter cable (  m ) x

Total requested length

Interconnection cables

LD34MI 450mm x  600mm x  750mm x

450mm x  600mm x  900mm x

1050mm  1350mm

Custom length  m x

Dimming option Yes  No

Please add a sketch of the requested layout if you feel it will help the quoting of this

Run three:

Customer reference:

Starter cable (  m ) x

Total requested length

Interconnection cables

LD34MI 450mm x  600mm x  750mm x

450mm x  600mm x

1050mm  1350mm

Custom length  m x

Dimming option Yes  No

Please add a sketch of the requested layout if you feel it will help the quoting of this

ORDER CODES & OPTIONS

Example: LD34MI-C1-700 / LW30 / OB / Silver / SC / GS40 / 600mm

Light Engine & Drive Current	LED Colour	Beam Angle	Finish	Fixing	Accessory	Length
LD34MI-C1-	/	/	/	/	/	/

WHITE LED ENGINES

**LINEAR C1 ENGINE**

1.7W LED at 500mA	LD34MI-C1-500	Super Warm White (2200K) /LW22	12° Narrow spot /NB				450mm /450
2.4W LED at 700mA	LD34MI-C1-700	Extra Warm White (2700K) /LW27	31° Medium /MB	Silver Anodised	/CH	/FD	600mm /600
		Warm White (3000K) /LW30	48° Wide /WB				750mm /750
		White (4000K) - on request /LW40	12° x 36° Oval Beam /OB	Paint Finish Classic Bronze (YM262E)		/GS40	1050mm /1050
		Cool White (5000K) /LW50	15° x 60° Extra Oval Beam /EOB			/GS50	1350mm /1350
				Paint Finish Black (RAL 9005)			
						/GL	
				Paint Finish Gunmetal Grey (RAL 7021)			
							
				Paint Finish Textured Fir Green (RAL 6009)			
							
				Paint Finish White (RAL 9016)			
							
				Paint Finish - RAL			

\*Add 18mm to the lengths above when supplied as a single length as flanged end caps are supplied fitted to product.

Drivers
Use with 350mA, 500mA & 700mA constant current LED drivers. We have a range of dimmable LED drivers DMX and DALI compatible. Please see the downloads section on our website