

## LD141G

COMPACT TRIMLESS INTERIOR/  
EXTERIOR RECESSED LED UPLIGHT/  
WALL LIGHT

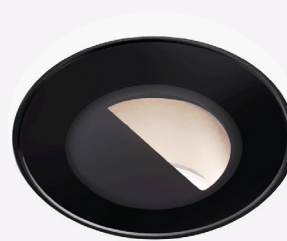

The LD141G has been designed for exterior applications, with an IP67 rating and a robust seamless all glass bezel. Compact in size, the fitting offers a powerful output with a large range of features. There are 2 LED engine options available. The E3 engine delivers a high output of 567 lumens and beam angles ranging from a 12° narrow to a 15° x 49° extra oval beam, whilst the F1 engine offers a super warm colour temperature of 2200K. Both configurations offer the ability to specify a 20° tilt film to angle the light down onto the lit surface for a more concentrated effect. Designed with our glass bezel, the LD141G offers a discreet, low-glare solution for a range of exterior-rated applications.



## KEY FEATURES

- > High-power E3 engine with NICHIA LED delivering up to 567lm at 700mA
- > F1 LED engine with CREE COB with super warm 2200K option
- > For exterior uplight applications
- > Durable all glass bezel, suitable for a wide range of applications
- > Range of beam angles including 12°, 19°, 34°, 54°, 15° x 49°
- > Optional 20° tilt film angles the light onto the lit surface for a concentrated effect
- > Optional glare shield and honeycomb louvre for further glare reduction
- > Fixing options include a rebated trimless fixing sleeve, concrete housing and ground tube
- >  Contains our integral moisture guard (anti-wicking barrier), stopping water ingress from going up the cable into the product from incorrect IP-rated connections
- > Switched, 0-10V, Casambi, DMX, DALI or Mains dimmable drivers available

## DIMENSIONS

*Dimensions in mm*

For fixing dimensions please go to page 3.



WHITE LED ENGINE SPECIFICATION

Engine	⊕ E3			⊙ F1		
Beam angles	12°, 19°, 34°, 54°, 15° x 49°			25°, 46°, 65°, 25° x 43°		
LED manufacturer	NICHIA			CREE		
Colour temperature*	2700K, 3000K, 4000K, 5000K			2200K, 2700K, 3000K, 4000K, 5000K		
Current [Rated Output]	350mA [5W]	500mA [7W]	700mA [10W]	350mA [3.5W]	500mA [5W]	700mA [7W]
Typical LED Circuit wattage	4.4W	6.4W	9.2W	3.3W	5W	7.2W
Delivered lumens (L <sub>100</sub> )*	379	462	567	266	290	375
Delivered lm/Circuit W**	85	72	62	68	58	52
Typical LED Source wattage	4W	5.8W	8.3W	3W	4.5W	6.5W
Source LED lm	574	740	949	377	497	654
Source lm/W	144	128	114	126	110	101
Forward voltage (V <sub>100</sub> )	11.3V	11.6V	11.8V	8.7V	9V	9.3V
CRI	85			90		
Colour consistency	2SCDM			3SCDM		
Peak intensity**	3,626 cd			1,885 cd		
LOR	0.60			0.57		
TM30	RF88   RG99			RF93   RG98		
UGR rating ('downlight' mounted) ***	10.7	11.4	12.2	8.8	9.6	10.5
BUG rating ('sideways' mounted)	B0-U3-G2			B0-U3-G2		
BUG rating ('uplight' mounted)	B0-U3-G0			B0-U3-G0		
LED lifetime	L90B5 at 90,000hrs			L90B5 at 90,000hrs		
Applications						

These values are based around a LD141G-E3-500-NB and LD141G-F1-500/MSB/LW30  
 \*See lumen variance table to the right for F1 engine. E3 lumens apply across all colour temperatures  
 \*\*LED wattage includes losses associated with using a 90% efficient driver  
 \*\*\*UGR values based on room parameters of 4H 8H, C70 W50 F20

Lumen variance by CCT	
2700K	+/- 0%
4000K	+7%
5000K	+16%

MECHANICAL

Ambient temperature	-20° to 50° (350mA-500mA) or -20° to 45° (700mA) in soil -20° to 50° (350mA-700mA) in concrete
Glass	6mm toughened glass with ceramic screen print
Materials	Black anodised aluminium body with black anodised bezel and glass front
Weight of product	0.25kg
IP rating	IP67
IK rating	IK08 (LD141X)
Wiring	In-series constant current wiring (pre-wired with 2-core exterior cable at a length of 250mm)

ENVIRONMENTAL

TM65	Available on request
TM66	2.7
Repair + Refurbish	This product is included in our Repair and Refurbish scheme. This offers customers the ability to send back products to us for repair or refurbishment to extend their life without having to buy new fittings.

**DIMENSIONS AND FIXING ACCESSORIES**

*Dimensions in mm*

**/441SG**

**Rebated trimless fixing sleeve**

The fitting can be supplied with a rebated fixing sleeve. This is bonded into the mounting surface first. The LD141G is secured into the sleeve by a single 'O' ring on the body. When pushed into the sleeve it creates a watertight seal. Mounting surface will require a 14mm rebate depth to allow for flush installation. Weight: 0.18kg. Fixing ring available with a passivated stainless steel or powder coat black finish.\*

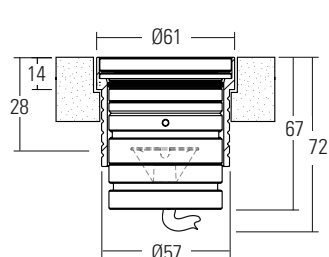

**/441GTG**

**Trimless ground tube fixing**

The in-ground tube has been designed for applications where a recessed uplight is required in soil or gravel surfaces. The tube can be buried with the necessary wiring, and then the fitting installed after the landscaping work has been completed. It is supplied with the fixing sleeve bonded into the tube and can be cut down on site. Weight: 1.26kg. Fixing ring available with a passivated stainless steel or powder coat black finish.\*

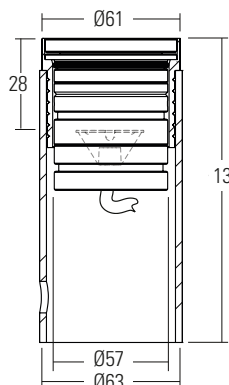

**/441NG or /441NG-2**

**Trimless concrete housing**

The aluminium housing is used as a heat sink which keeps the LED fitting cool through the thermal transfer of the heat within the housing to the surrounding concrete. The housings are big enough for IP rated connections to be made inside the housing and a second gland is available for cabling onto the next luminaire. The housing can be buried with the necessary wiring, and then the fitting installed after the landscaping work has been completed. Weight: 2.90kg. Fixing ring available with a passivated stainless steel or powder coat black finish.\*

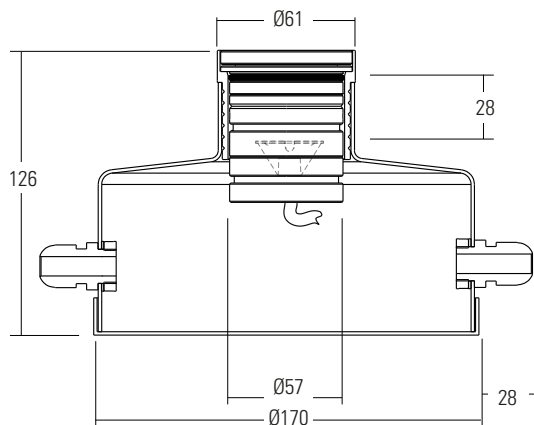

**/441NG**

Trimless concrete housing with 1x PG9 IP67 gland



**/441NG-2**

Trimless concrete housing with 2x PG9 IP67 gland



\*NOTE: Powder coat black paint finish is not suitable for high-traffic areas.

**/HT-44-G Trimless Family Hand tool**

We supply our Trimless family fittings with a hand tool for easy installation and removal. Use the /HT-44-G suction cup or a similar suction tool for the removal of the fittings from their fixing options. Please contact your LightGraphix sales representative for more information.



**How to use the hand tool**

- 1 Set tool to a 90° angle.
- 2 Press tool firmly onto glass.
- 3 Tilt handle up to create suction, and pull directly upwards to remove fitting.  
*Note:* Do not twist during removal as this could damage the bezel.

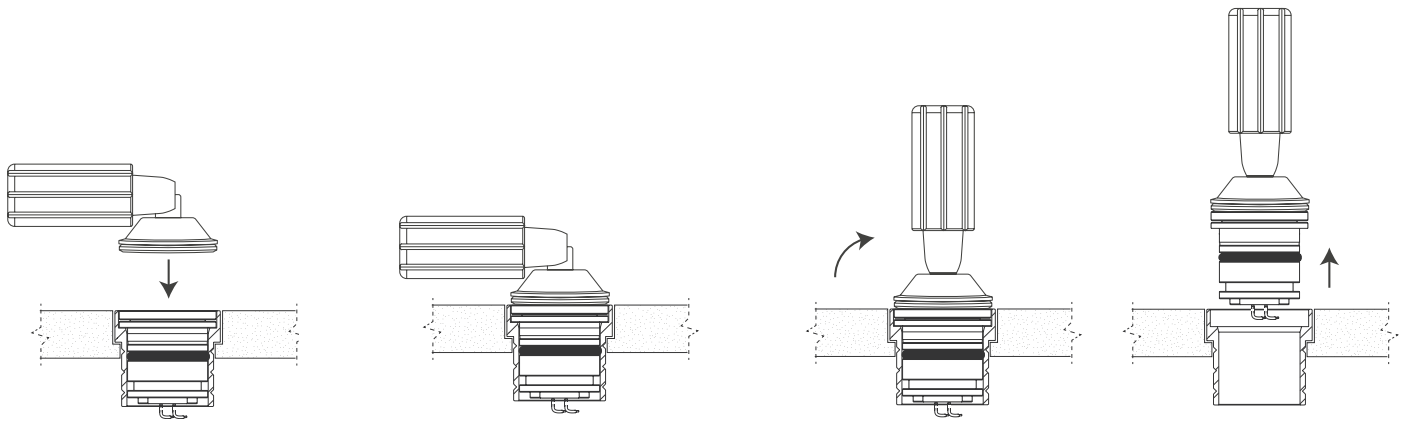

**GLARE CONTROL OPTIONS**

**/NGS** No glare shield. Deep recessed optic and matt black anodised optic holder aids in glare reduction.

**/GSHM** For applications that require low glare. Lumen output is typically reduced by 60% with no light lost on the lit surface.

**/HL** Helps reduce glare from all angles and can be used with glare shields. The honeycomb louvre cannot be specified with the tilt lens option.



## LIGHT OUTPUT OPTIONS

### LD141G without tilt lens

Ideal for discreet lighting applications where a throw of light is required.

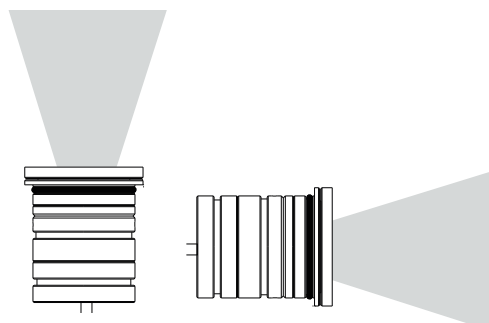

### LD141G with tilt lens

The addition of a 20° tilt film focuses the light towards the lit surface for a more concentrated effect.

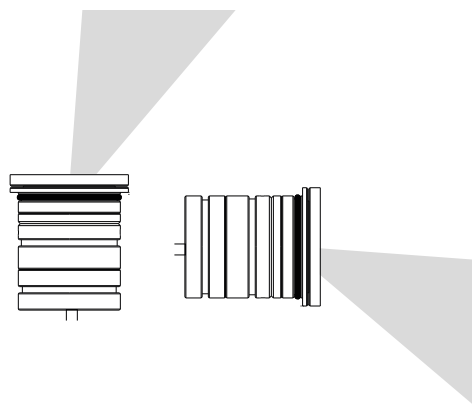

## CONE DIAGRAMS

### E3 LED Engine

Cone diagrams below are based on a 3000K E3 LED engine run at maximum output 500mA, 7W. Images below represents beam outputs when wall washing a 3m wall, spaced 125mm away from the lit surface. Photometric files (LDT) are included in the design pack which can be downloaded from the LD141 product page on the website.

#### Narrow Beam 500mA using a 12° optic

Distance (m)	Cone Width (m)	Luminance (lx)
3.0	0.82	406
2.5	0.68	585
2.0	0.55	914
1.5	0.41	1625
1.0	0.27	3656
0.5	0.14	14624

#### Medium Beam 500mA using a 19° optic

Distance (m)	Cone Width (m)	Luminance (lx)
3.0	0.96	387
2.5	0.80	557
2.0	0.64	871
1.5	0.48	1548
1.0	0.32	3483
0.5	0.16	13933

#### Wide Beam 500mA using a 34° optic

Distance (m)	Cone Width (m)	Luminance (lx)
3.0	1.64	139
2.5	1.37	200
2.0	1.09	312
1.5	0.82	555
1.0	0.55	1249
0.5	0.27	4495

#### Extra Wide Beam 500mA using a 54° optic

Distance (m)	Cone Width (m)	Luminance (lx)
3.0	3.02	50
2.5	2.51	72
2.0	2.01	112
1.5	1.51	199
1.0	1.01	448
0.5	0.50	1791

#### Extra Oval Beam 500mA using a 15° X 49° optic

Distance (m)	Cone Width (m)	Luminance (lx)
3.0	1.77 / 0.90	181
2.5	1.47 / 0.75	260
2.0	1.18 / 0.60	407
1.5	0.88 / 0.45	723
1.0	0.59 / 0.30	1627
0.5	0.29 / 0.15	6510

### F1 LED Engine

Cone diagrams below are based on a 3000K F1 LED engine run at maximum output 500mA, 5W. Images below represents beam outputs when wall washing a 3m wall, spaced 125mm away from the lit surface. Photometric files (LDT) are included in the design pack which can be downloaded from the LD141 product page on the website.

#### Medium Spot Beam 500mA using a 25° optic

Distance (m)	Cone Width (m)	Luminance (lx)
3.0	1.10	212
2.5	0.92	305
2.0	0.73	476
1.5	0.55	847
1.0	0.37	1905
0.5	0.18	7621

#### Wide Beam 500mA using a 46° optic

Distance (m)	Cone Width (m)	Luminance (lx)
3.0	1.82	79
2.5	1.52	113
2.0	1.22	177
1.5	0.91	315
1.0	0.61	709
0.5	0.30	2835

#### Extra Wide Beam 500mA using a 65° optic

Distance (m)	Cone Width (m)	Luminance (lx)
3.0	2.87	40
2.5	2.40	57
2.0	1.92	90
1.5	1.44	158
1.0	0.96	358
0.5	0.48	1432

#### Extra Oval Beam 500mA using a 25° X 43° optic







Distance (m)	Cone Width (m)	Luminance (lx)
3.0	0.93 / 2.58	112
2.5	0.77 / 2.15	161
2.0	0.62 / 1.72	251
1.5	0.46 / 1.29	447
1.0	0.31 / 0.86	1005
0.5	0.15 / 0.43	4020

ORDER CODES & OPTIONS

Example: LD141G-E3-500 / LW30 / OB / L / GS / 316 STAINLESS STEEL / 441SG

Light Engine & Drive Current / LED Colour / Beam Angle / Optical option / Glare shield / Fixing / Fixing Finish

**E3**

5W LED at 350mA	LD141G-E3-350	Extra Warm White (2700K)	/LW27	12° Narrow	/NB	20° tilt	A			Passivated Stainless Steel  Paint finish Black (Powder Coat)
7W LED at 500mA	LD141G-E3-500	Warm White (3000K)	/LW30	19° Medium	/MB	No tilt	L			
10W LED at 700mA	LD141G-E3-700	White (4000K) - on request	/LW40	34° Wide	/WB					
		Cool White (5000K)	/LW50	54° Extra Wide	/WWB					
				15° x 49° Extra Oval Beam	/EOB					

**F1**

3.5W LED at 350mA	LD141G-F1-350	Super Warm White (2200K)	/LW22	25° Medium spot	/MSB					
5W LED at 500mA	LD141G-F1-500	Extra Warm White (2700K)	/LW27	46° Wide	/WB					
7W LED at 700mA	LD141G-F1-700	Warm White (3000K)	/LW30	65° Extra wide	/WWB					
		White (4000K) - on request	/LW40	25° x 43° Oval	/EOB					
		Cool White (5000K)	/LW50							

**Drivers**  
Use with 350mA, 500mA and 700mA constant current LED drivers  
We have a range of dimmable LED drivers including DMX and DALI compatible. Please see the downloads section on our website.