

LD53

EXTERIOR RATED, LOW LEVEL, DIFFUSED,
360°, LANDSCAPE ACCENT LIGHT



The LD53 exterior landscape accent light is designed to wash surfaces with a soft glow, highlighting specific areas of interest. With a custom LightGraphix reflector and LED array, it offers a wide, low-level, 360°, diffused wash of light from a very compact fitting. It is available in RGBW or standard white colour temperatures from 2400K to 5000K. An optional adjustable head is available, allowing up to 20° tilt via an innovative toolless adjustable locking mechanism, allowing quick onsite adjustment. This versatile product can be used in-ground, on tabletops and on walls, allowing for a consistent lighting effect across a project and can be further enhanced through our wide range of paint finishes.





KEY FEATURES

- > Provides a wide, low-level, 360°, diffused wash of light from a very compact fitting, with very low glare
- > Minimalist and timeless design
- > Wide range of white LED colours from 2400K to 5000K
- > RGBW light engine available with incredible colour mixing capability
- > 24V input allowing multiple fitting to be wired in parallel
- > Optional adjustable head can be tilted up to 20° and locked using knurled collar for toolless on-site focusing
- > Wide range of fixing options and Ground Spike heights, as well as a Surface Mount Base, and Surface Mount Base Extended
- > Dark sky lighting is achieved by focussing the light down and using a semi-recessed opal diffuser and optics, allowing for no upward spill of light
- > Features an anti-wicking barrier to increase protection against moisture ingress
- > Wide range of wet spray and textured paint finishes available including: White (RAL 9016), Silver anodised, Anthracite Grey (RAL 7016), Black (RAL 9005), Antique Bronze, Satin Antique Brass, Satin Brass, Textured Fir Green (RAL 6009), Textured Mars Bronze (SX350F) or any RAL finish
- > Switched, 0-10V, Casambi, DMX, DALI or Mains dimmable drivers/controllers available

DIMENSIONS



LED ENGINE SPECIFICATION

Engine	 LG2000	 RGBW			
LED manufacturer	Osram	Osram			
Colour temperature	2400K, 2700K, 3000K, 4000K, 5000K	Red	Green	Blue	White (4000K)
LED power (Max)	5.4W	2.7W	2.3W	1.8W	3.6W
Delivered lumens (L ₁₀₀)	310	25.6	45	6.18	116
Lumens per circuit watt	44	9.6	19.7	3.4	31.7
CRI (Typ)	93.5	-			
Forward voltage (V ₁₀₀)	24V constant voltage	24V constant voltage			
Colour consistency	3 SDCM	-			
Peak intensity	110 cd	8.75cd	15.3cd	2.07cd	39.9cd
LED Lumens	540lm	382.5lm			
LOR	0.57	0.57			
TM30	RF90.8	RG102.3		-	
LED lifetime	50,000hrs (to 70% lumen output)				
Applications					

These values are based around a LD53/27K and an LD53/RGBW

MECHANICAL

Ambient temperature	LF2000	-20°C to 50°C
	RGBW	-30°C to 50°C
Diffuser	3mm Acrylic Opal 050	
Materials	Anodised aluminium 6026 body and ground spike	
Weight of product	392g	
IP rating	IP65	
Wiring	Parallel constant voltage wiring 24V	

ENVIRONMENTAL

TM65	Available on request
TM66	2.5

AVAILABLE FINISHES

Please refer to our finishes guide for full details

The LD53 body and ground spikes are machined from aluminium, anodised, and then painted in-house at LightGraphix. Paint finishes are suitable for interior and exterior use. Our standard colours are below but we can accommodate any RAL request. Please view our full finishes guide online for more information.

WET SPRAY

Wet spray paint offers a fine coating and has a realistic metallic finish. It is suitable for interior, exterior and high-saline environments.



BLACK
(RAL 9005)



WHITE
(RAL 9016)



SILVER ANODISED



ANTIQUE BRONZE



SATIN ANTIQUE BRASS



SATIN BRASS



ANTHRACITE GREY
(RAL 7016)



TEXTURED FIR GREEN



RAL COLOURS

POWDER COAT

Powder coat paint is offered in special textured finishes, which are suitable for interior, exterior and high-saline environments.



TEXTURED MARS BRONZE
(SX350F)

ADJUSTABILITY

LD53 is available with an adjustable head with 20° lockable tilt, for applications that require the light to be angled away which can help with reducing glare. An innovative knurled collar allows for toolless easy on-site focusing and locking of the tilt.



LD53/27K/Black/0515396

WHITE & RGBW LED ENGINES

The LD53 has excellent RGBW capabilities. With the 5-core cable you are able to set the LED to any shade on the colour spectrum, easily adapting to any environment. The fitting is also available in all of our standard colour temperatures, including very warm white 2400K.



OPAL DIFFUSER

The LightGraphix reflector, LED array and opal diffuser creates a wide, diffused wash of light with no spotting of the LEDs. The addition of a lip protruding beyond the diffuser works to reduce visual glare.



DIMENSIONS & FIXING OPTIONS

Dimensions in mm

/GSF53-6/9/12 Fixed Ground Spike 600mm, 900mm or 1200mm

The Fixed Ground Spike is manufactured out of aluminium and is available in three lengths, 600mm, 900mm or 1200mm, painted to match the body.

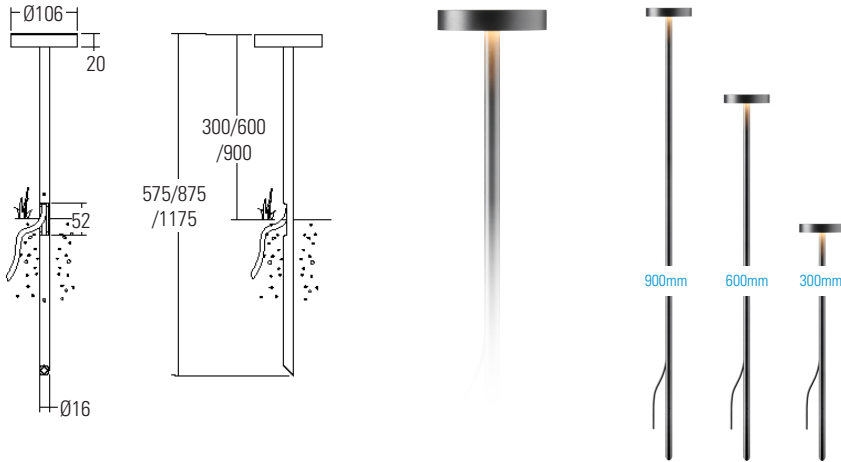

/GSAT53-6/9/12 Ground Spike with Adjustable Tilt 600mm, 900mm or 1200mm

The Ground Spike with Adjustable Tilt is manufactured out of aluminium and is available in three lengths, 600mm, 900mm or 1200mm, painted to match the body, including a lockable and tiltable head up to 20°.

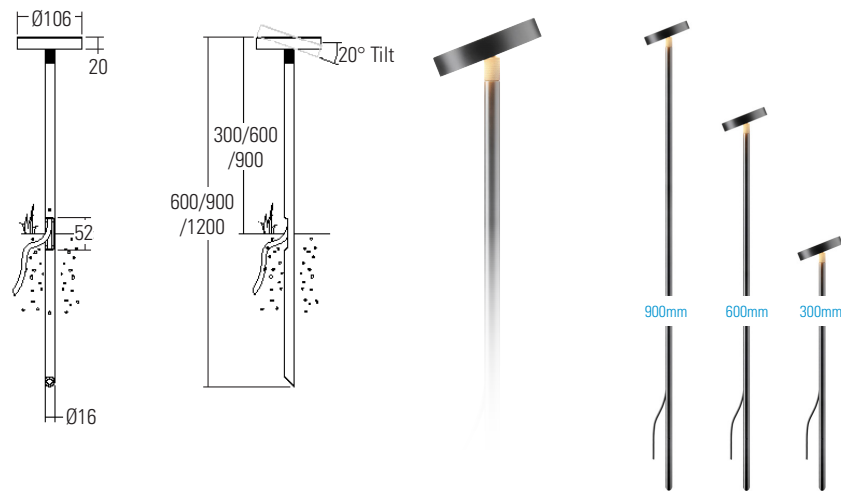

/GSP Ground Spike Plate

Gives extra support for applications with soft ground by being buried attached to the ground spike stem.

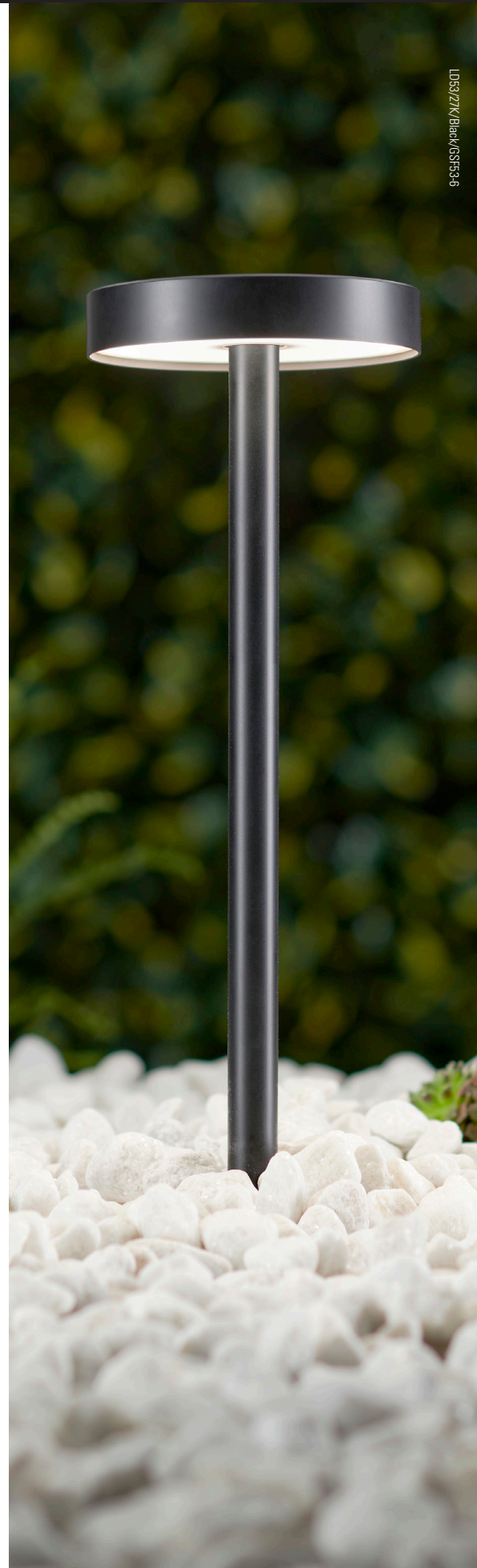
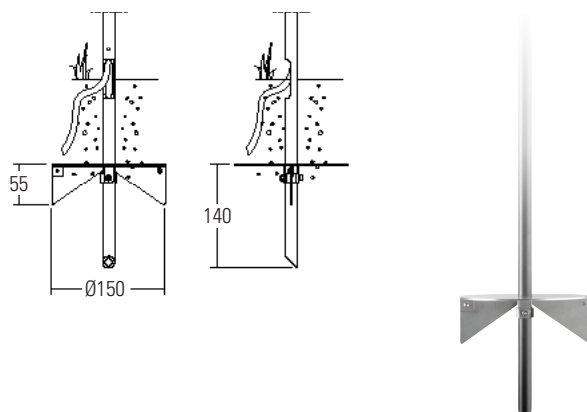

LD53/27K/Black/GSF53-6

/SMB53

Surface Mount Base

Surface Mount Base is supplied as standard with a very short stem and minimal fixings, for wall or accent light applications. The cable can either be hidden and routed through the mounting surface or run through the side of the base via a removable grub screw.

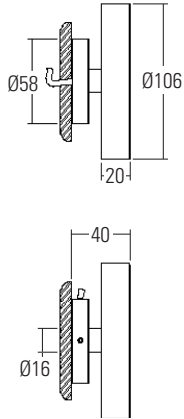

/SMBEX53-100/200/300

**Surface Mount Base Extended
100/200/300mm**

SMBEX offers hidden wiring and strong base plate for solid surface applications, allowing the fitting to be screwed down directly. The cable can either be hidden and routed through the mounting surface or run through the side of the base via a removable grub screw. Available in 100mm length increments from 100mm up to 300mm.

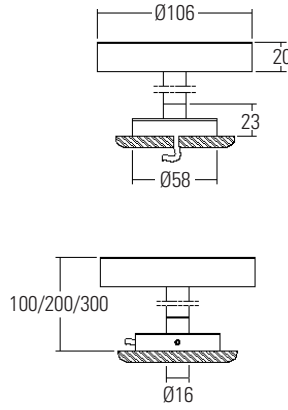

/SMBEXAT53-100/200/300

**Adjustable Tilt Surface Mount Base Extended
100/200/300mm**

The SMBEX with Adjustable Tilt offers hidden wiring and allows the fitting to be screwed directly onto the solid mounting surface, as well as a lockable and tiltable head up to 20°. The cable can either be hidden and routed through the mounting surface or run through the side of the base via a removable grub screw. Available in 100mm increments from 100mm up to 300mm.

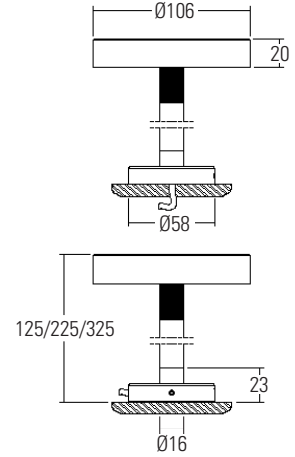

LD53/271/Black/SMB53



LD53/271/Black/SMBEX53

ORDER CODES & OPTIONS

Example: LD53/27K/Black/GSAT53-6

Light Engine & Drive Current

LED Colour

Finish

Fixings & Accessories

LD53 / / /













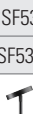



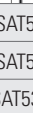

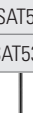



 **White**

24V 5.4W LD53 (LG2000)

Very Warm White (2400K)	/LW24
Extra Warm White (2700K)	/LW27
Warm White (3000K)	/LW30
White (4000K) - on request	/LW40
Cool White (5000K)	/LW50

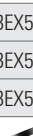
 **RGBW**

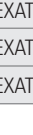
24V 5.4W LD53-RGBW

	WET SPRAY /Black (RAL 9005)		/GSF53-6
	WET SPRAY /White (RAL 9016)		/GSF53-9
	WET SPRAY /Silver Anodised		/GSF53-12
	WET SPRAY /Antique Bronze		/GSAT53-6
	WET SPRAY /Satin Antique Brass		/GSAT53-9
	WET SPRAY /Satin Brass		/GSAT53-12
	WET SPRAY /Anthracite Grey (RAL 7016)		/GSP53
	WET SPRAY /Textured Fir Green (RAL 6009)		/SMB53
	POWDER COAT /Textured Mars Bronze (SX350F)		/SMBEX53-100
	PAINT FINISH /Any RAL		/SMBEX53-200
			/SMBEX53-300
			/SMBEXAT53-100
			/SMBEXAT53-200
			/SMBEXAT53-300

Drivers
To be used with 24V constant voltage LED Drivers and Controllers
We offer a range of drivers with 1-10V, DMX, and DALI dimming options.
Please download the data sheet from the downloads section at www.lightgraphix.co.uk, or contact us for more information.