

LD1093Z & LD1093
MARINE-GRADE TRIMLESS MODULAR
ADJUSTABLE LED DOWNLIGHT

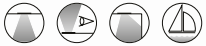

5 YEAR
Warranty



The LD1093Z/LD1093 is a high-power, IP67, adjustable recessed downlight engineered specifically for demanding marine environments. This modular lighting solution offers a choice between 'Zero' trimless bezel (LD1093Z) or trimmed bezel (LD1093). It has an innovative ball joint allowing the lens assembly to be rotated 360°, tilted at up to 25° and locked in place with a simple one-handed twist. Post-installation focusing is quick and efficient, with no need to remove the product from its mounting surface.

The LD1093Z/LD1093 is compatible with a variety of concealed fixing options, making it adaptable to a wide range of ceiling types, including suspended/drop panel ceilings and thicknesses down to 1mm. With a light output exceeding 1000 delivered lumens, this product is available with the E3 or N1 LED engine, offering colour temperatures ranging from 2200K to 5000K. Choose from a variety of beam angles, from 12° to 65°, as well as two oval options. Designed for adaptability, this robust downlight ensures exceptional thermal management and light performance, making it the ideal solution for marine environments.



LD1093Z - Trimless Zero Bezel



LD1093 - Trimmed Bezel

KEY FEATURES

- > Zero Trim (trimless) and trimmed bezels available to suit different applications.
- > Innovative lockable 360° rotating ball-joint can be positioned in any direction and tilted up to 25° for ultimate flexibility when focusing onsite
- > Quick and easy on-site focusing once the product is installed
- > Very shallow depth, ideal for height restricted applications
- > Rated IP67
- > Interchangeable optics and glare control accessories including honeycomb louvre
- > Beam angles ranging from 12° Narrow, to 65° Extra Wide, and 2 Oval options
- > E3 and N1 LED engines available, producing up to 1032 lumens in 3000K at 700mA
- > Single optic produces superior beam shape and no multiple shadows
- > High quality machined bezel available in: Polished & Passivated 316 Stainless Steel, 316 Stainless Steel, White (RAL 9016), Black (RAL 9005), Classic Bronze, Textured Mars Bronze, Textured Fir Green, Gunmetal Grey and any RAL colour
- > Various hidden fixing methods for multiple ceiling types
- >  Contains our integral moisture guard (anti-wicking barrier), stopping water ingress from going up the cable into the product from incorrect IP-rated connections
- > Switched, 0-10V, Casambi, DMX, DALI or Mains dimmable drivers available

DIMENSIONS

For full dimensions please go to page 4.



WHITE LED ENGINE SPECIFICATION

Engine	⊕ E3			⊙ N1		
Beam angles	12°, 19°, 34°, 55°, 15° x 49°			25°, 35°, 46°, 65°, 22° x 43°		
LED manufacturer	NICHIA			CREE		
Colour temperature*	2700K, 3000K, 4000K, 5000K			2200K, 2700K, 3000K, 4000K, 5000K		
Current [Rated Output]	350mA [5W]	500mA [7W]	700mA [10W]	350mA [7W]	500mA [10W]	700mA [14W]
Typical LED Circuit wattage	4.4W	6.4W	9.2W	6.4W	9.3W	13.3W
Delivered lumens (L ₁₀₀)*	437	570	747	591	790	1032
Delivered lm/Circuit W**	98	89	81	92	85	77
Typical LED Source wattage	4W	5.8W	8.3W	5.8W	8.4W	12.0W
Source LED lm	574	740	949	694	937	1264
Source lm/W	144	128	114	120	112	105
Forward voltage (V ₁₀₀)	11.3V	11.6V	11.8V	16.6V	16.8V	17.1V
CRI	85			93		
Colour consistency	2 SDCM			2 SDCM		
Peak intensity	7,799 cd			5,079 cd		
LOR	0.79			0.82		
TM30	RF86 RG98			RF92 RG100		
UGR rating ('downlight' mounted)***	8.9	9.8	10.9	11.5	12.5	13.4
BUG rating ('downlight' mounted)	B1-U0-G0			B1-U0-G0		
LED lifetime	L90B5 at 90,000hrs			L90B5 at 90,000hrs		
Applications						

These values are based on LD1093-E3-700-LW30-NB and LD1093-N1-700-LW30-NB
 *See lumen variance table to the right for N1 engine. E3 lumens apply across all colour temperatures
 **LED wattage includes losses associated with using a 90% efficient driver
 ***UGR values based on room parameter of 4H, 8H, C70 W50 F20

Lumen variance by CCT	
2200K	-7%
2700K	+/- 0%
4000K	+7%
5000K	+16%

MECHANICAL

Ambient temperature	-20°C to 35°C (350mA/500mA/700mA)
Glass	1mm thick, low iron glass
Materials	Aluminium, Stainless Steel, Glass
Weight of product	700g
IP rating	IP67
Wiring	External 2 core cable, 400mm

ENVIRONMENTAL

TM65	Available on request
TM66	2.5
Repair + Refurbish	This product is included in our Repair and Refurbish scheme. This offers customers the ability to send back products to us for repair or refurbishment to extend their life without having to buy new fittings.

AVAILABLE FINISHES

Please refer to our finishes guide for full details



POLISHED & PASSIVATED 316 STAINLESS STEEL

- > Marine Grade 316 Stainless Steel
- > Pristine mirror like finish
- > Recommended for pools and marine applications
- > Extremely durable with very high corrosion resistance
- > Passivated to extensively prolong resistance to corrosion and brown stains caused by oxidation in marine environments
- > Interior & exterior use

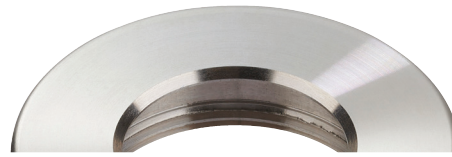

316 STAINLESS STEEL

- > Marine grade 316 Stainless Steel
- > Standard machined finish
- > Extremely durable
- > Passivation recommended for marine environments to prevent corrosion and build up of brown stains caused by oxidation
- > Interior & exterior use

PAINT FINISH - POWDER COAT

- > The powder coat finish has a very matte appearance.
- > Powder coat paint is generally used on stainless steel or anodised aluminium components
- > Interior and exterior use



WHITE
(RAL 9016)



BLACK
(RAL 9005)



CLASSIC BRONZE
(YM262E)



TEXTURED MARS BRONZE



TEXTURED FIR GREEN
(RAL 6009)



GUNMETAL GREY
(RAL 7021)

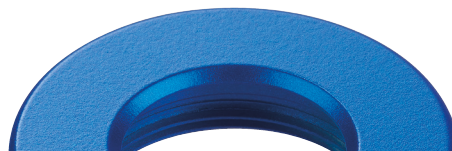

RAL COLOURS

DIMENSIONS

LD1093Z Trimless Zero Bezel

The LD1093Z provides a flush-finished, sleek and discreet look, focusing on the lit effect and low glare aspects of the fitting.

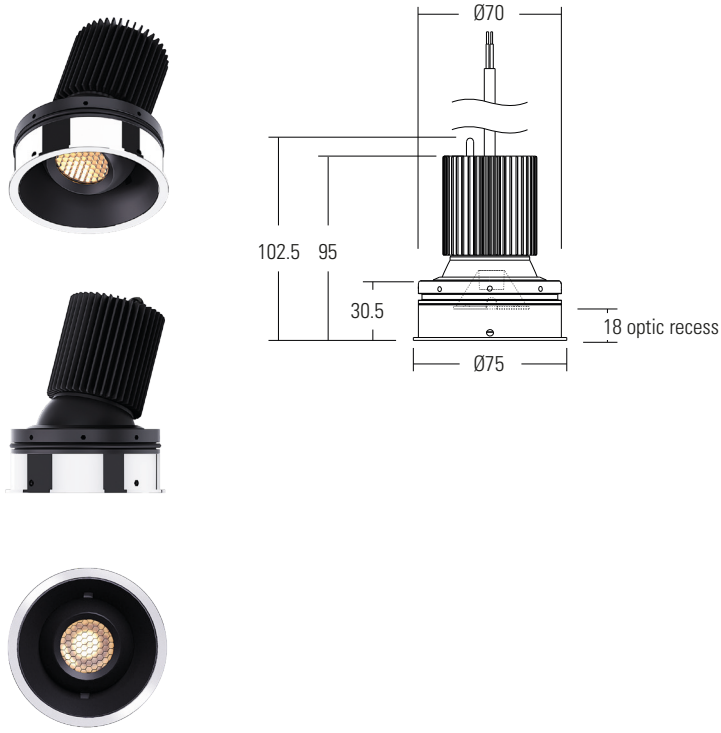





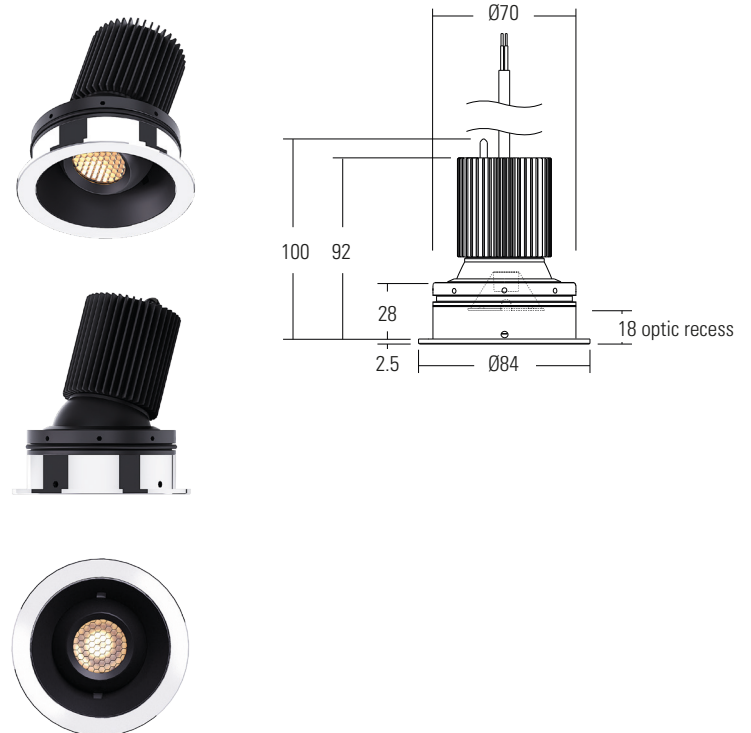

LD1093 Trimmed Bezel

The LD1093 allows for more traditional push fit installation with the spring clips or sleeve and spring, and fitting in less accurately cut holes than the LD1093Z. Finish customisation is also possible using our in-house powder coat paint options, all of which are thoroughly tested in harsh conditions.

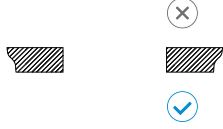
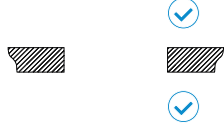
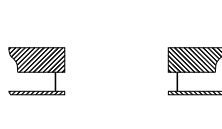

CEILING COMPATIBILITY

The below table shows typical ceiling scenarios - ie whether the installer only has access to the front of the ceiling, to the front and back, or if there is a removable panel on the ceiling, and the compatible ceiling thickness range for each product and mounting combination

		Front Access Only	Front + Rear Access	Suspended Panel Ceiling
		For 'traditional' fixed ceiling installations, with no access to the rear ceiling void side.	For when you have access to the front and the rear void of the ceiling, eg removable panels.	For suspended removable panels, allowing seamless and secure installation to the top fixed ceiling surface.
				
LD1093Z Trimless Zero Bezel	 /493XPR Expansion Ring Page 6	12mm minimum thickness	12mm minimum thickness	x
	 /493CMR Ceiling Mount Ring Page 7	x	1mm minimum thickness	1mm minimum thickness
	 /493SMS Surface Mount Sleeve Page 8	x	x	1mm minimum thickness
LD1093 Trimmed Bezel	 /493XPR Expansion Ring Page 9	1mm minimum thickness	1mm minimum thickness	x
	 /SC Spring Clips Page 10	6-18mm minimum thickness	6-18mm minimum thickness	x
	 /493S Sleeve & Spring Clips Page 10	3mm minimum thickness	3mm minimum thickness	x

LD1093Z DIMENSIONS AND FIXING OPTIONS

Dimensions in mm

/493XPR Expansion Ring

This is a brand-new fixing type for LightGraphix, designed specifically to eliminate the possibility of any ceiling damage. The fixing is secured into the recess with an innovative expanding sleeve, which holds the luminaire securely and is fitted and fixed from the front of the fitting. **Available on the LD1093Z & LD1093**



HOW TO INSTALL THE 493XPR

1 Cut out hole - Ø76mm. Place fixing into the cut-out.

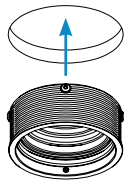

2 Tighten built in screws in the bezel to expand the fitting sleeve into place.

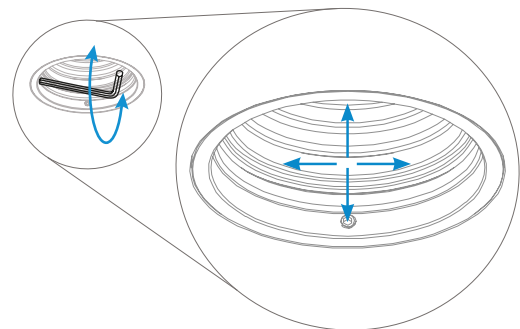

3 Install LED engine, adjust and focus the LD1093Z then lock in place with the hand tool.

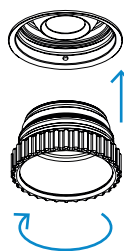

/493CMR Ceiling Mount Ring

The ceiling mount ring fixes to the top side of a ceiling or removable panel. It allows adjustment to the product depth to fit a range of thicknesses of ceiling, panel, or for where a removable panel is placed directly over a fixed ceiling structure. **Available on the LD1093Z only.**

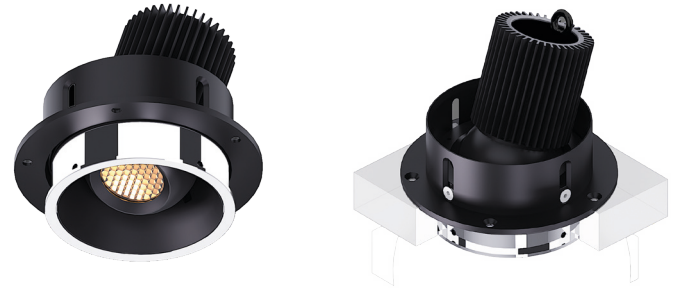
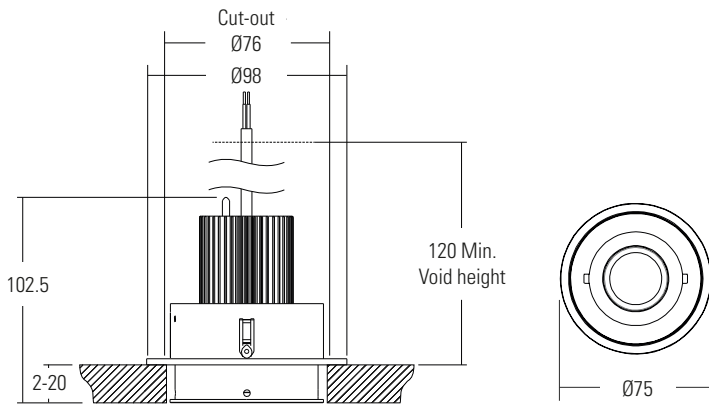

HOW TO INSTALL THE 493CMR

- 1 Cut out hole - $\text{Ø}76$. Place fixing up into the cut-out.

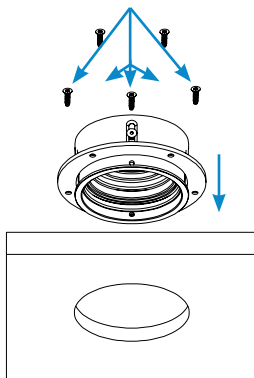

- 2 Loosen adjustment screws, set the bezel to the desired height, re-tighten screws.

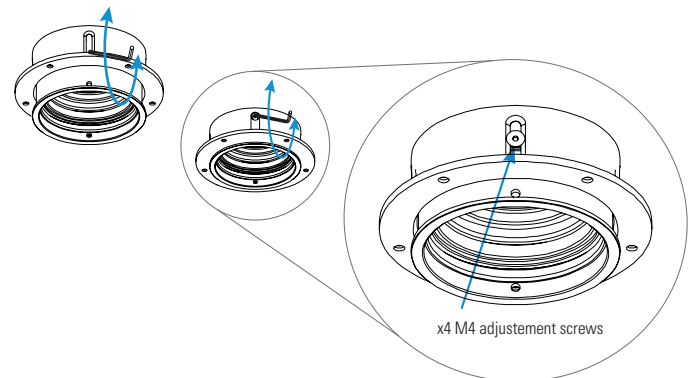

- 3 Install LED engine, adjust and focus the LD1093Z then lock in place with the hand tool.

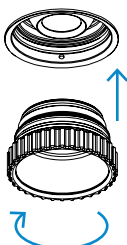

/493SMS Surface Mount Sleeve

This fixing method is designed specifically for removable panel / drop ceiling applications. The sleeve is mounted to the surface before the drop ceiling is installed, allowing the fitting to be adjusted to the correct distance. The drop ceiling can then be placed, removed and changed without the need to re-install the fitting. **Available on the LD1093Z only.**

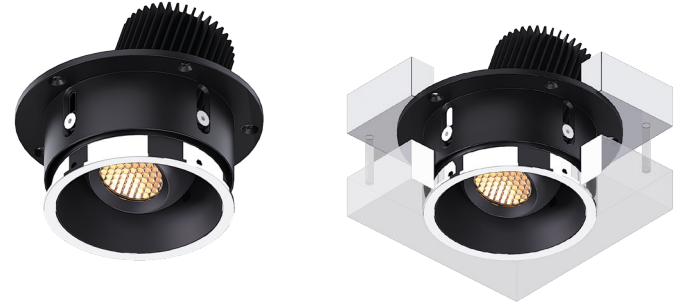
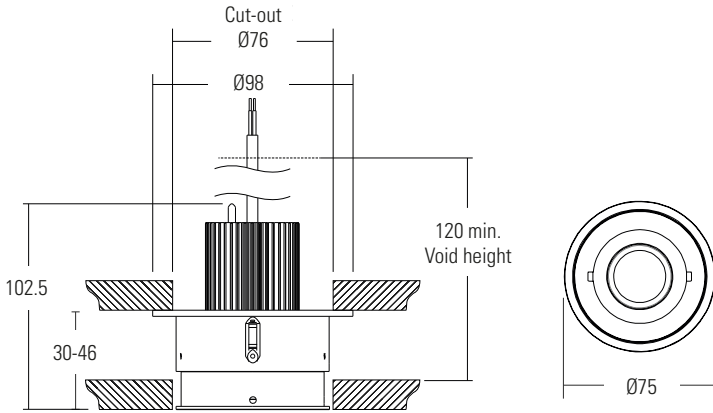

HOW TO INSTALL THE 493SMS

- 1 Cut out hole - Ø76. Place fixing up into the cut-out.

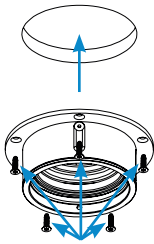

- 2 Loosen adjustment screws, set the bezel to the desired height, re-tighten screws.

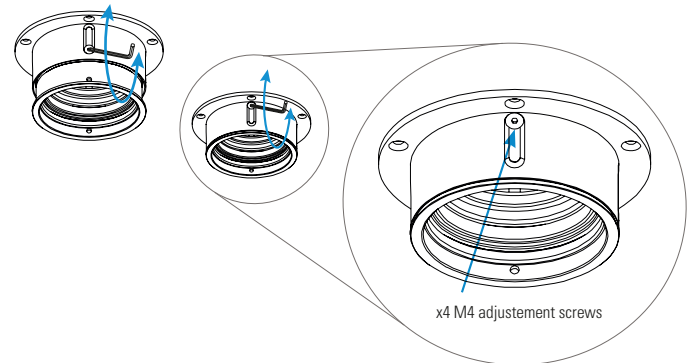

- 3 Offer up the removable ceiling panel (with a cutout for the 75.2mm bezel diameter)

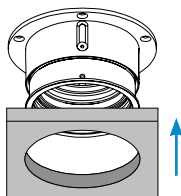

- 4 Install LED engine, adjust and focus the LD1093Z then lock in place with the hand tool.

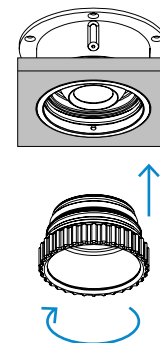

LD1093 DIMENSIONS AND FIXING OPTIONS

Dimensions in mm

/493XPR Expansion Ring

This is a brand-new fixing type for LightGraphix, designed specifically to eliminate the possibility of any ceiling damage. The fixing is secured into the recess with an innovative expanding sleeve, which holds the luminaire securely and is fitted and fixed from the front of the fitting. **Available on the LD1093Z & LD1093**

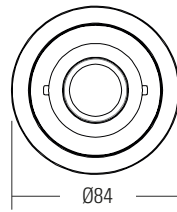
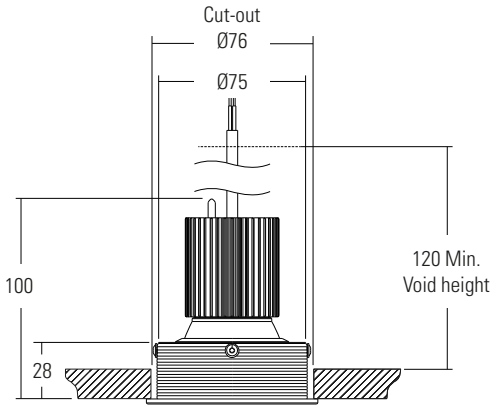

HOW TO INSTALL THE 493XPR

- 1 Cut out hole - 76mm. Place fixing into the cut-out.

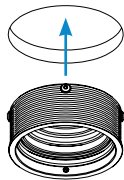

- 2 Tighten built in screws in the bezel to expand the fitting sleeve into place.

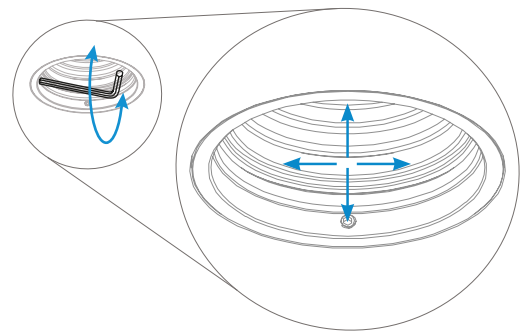

- 3 Install LED engine, adjust and focus the LD1093 then lock in place with the hand tool.

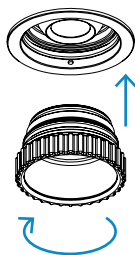

/SC Spring Clips

Provides a simple single-fix mounting method for the LD1093. **Available on the LD1093 only.**

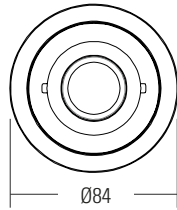
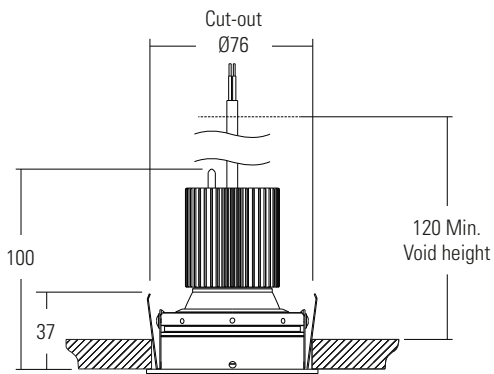

/493S Sleeve + Spring Clips

A new fixing method from LightGraphix for the LD1093. It comprises of a robust sleeve with added spring clips to prevent the product from twisting during adjustment once installed. **Available on the LD1093 only.**

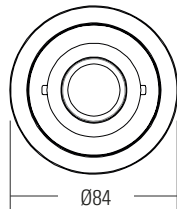
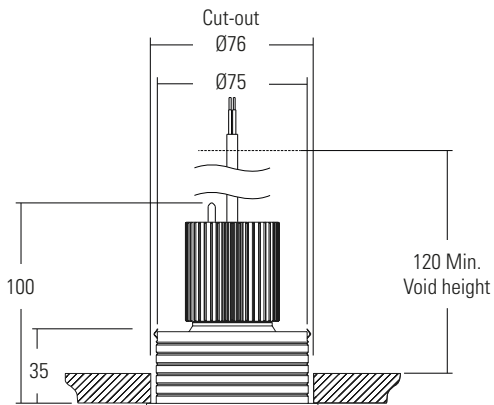

HOW TO INSTALL THE 493S

1 Cut out hole - Ø76mm.

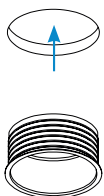

2 Bond in sleeve

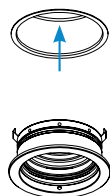

3 Push product into sleeve and rotate until a 'click' is heard and felt

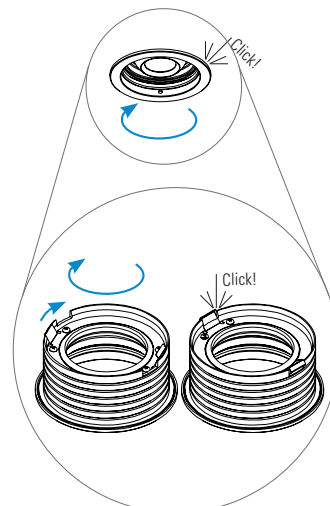

4 Install LED engine, adjust and focus the LD1093 then lock in place with the hand tool.

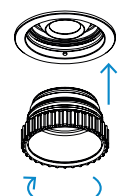

GLARE CONTROL OPTIONS

/NGS No glare accessory

No glare shield. Low glare optic and matt black anodised optic holder aids in glare reduction.

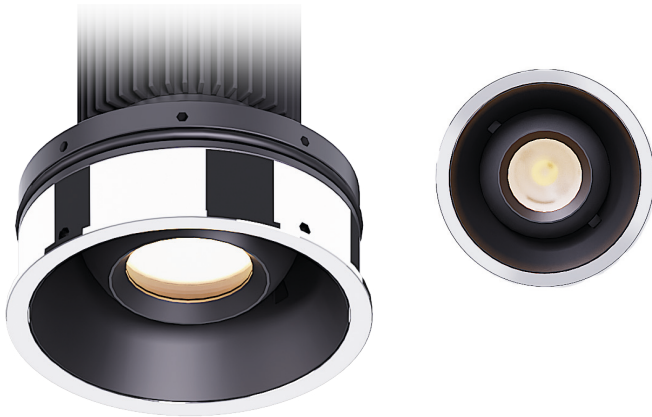

/HL Honeycomb louvre

Helps reduce glare from all angles.



LOCKABLE ADJUSTABILITY

Featuring an innovative 360° rotating ball-joint, the lens assembly can be positioned in any direction and tilted up to 25° for ultimate flexibility when focusing on-site. The assembly includes a lockable matt black baffle designed for glare reduction and is easily secured with using the /1093HT hand tool.

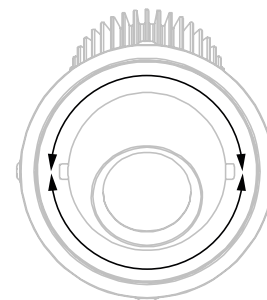
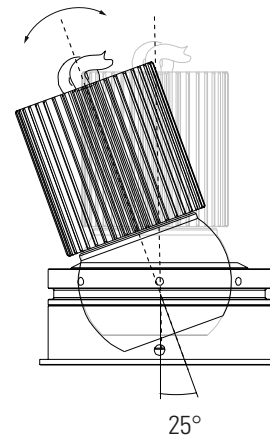

HT1093 HAND TOOL

/HT1093 Hand tool

Adjustability of the luminaire and ball joint is very simple using the small custom tool. The hand tool is required to unscrew the bezel and tilt the rotating ball-joint into the desired position for quick on-site focusing. This tool is supplied separately.

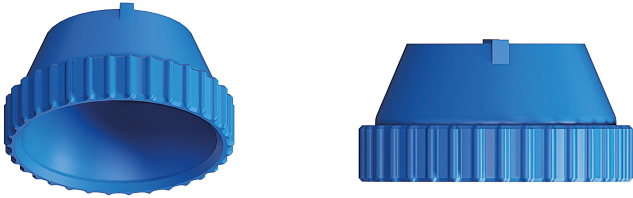

HOW TO ADJUST THE LIGHT ANGLE USING THE HAND TOOL

- 1 Gently loosen the baffle.

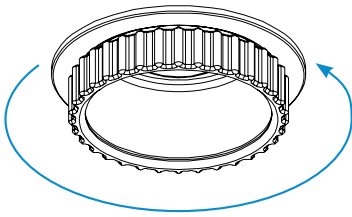

- 3 Tighten baffle until unable to tighten anymore. The ball should be secure and locked into position.

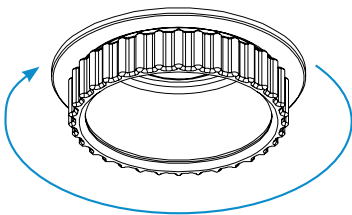

- 2 Adjust ball to desired angle. Make all tilt adjustments by hand.

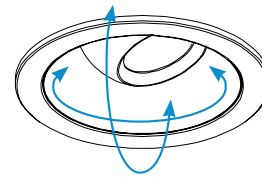

- 4 Remove tool from fitting. Confirm adjustment was successful by powering up the fitting.

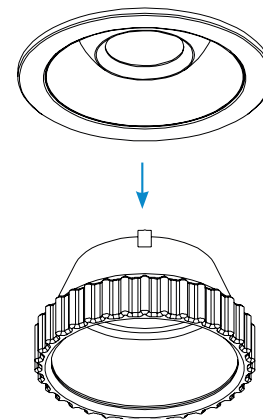

SAFETY TETHER

The fitting is equipped with a safety tether fixing point for optional extra security on installation.



CONE DIAGRAMS

E3 LED Engine

Cone diagrams below are based on a 3000K E3 LED engine run at maximum output 700mA, 10W. Images below represents beam outputs when wall washing a 3m wall, spaced 125mm away from the lit surface. Photometric files (LDT) are included in the design pack which can be downloaded from the LD1093/Z product pages on the website.

Narrow Beam
700mA using a 12° optic

Distance (m)	Cone Width (m)	Luminance (lx)
0.5	0.13	31186
1.0	0.26	7797
1.5	0.38	3465
2.0	0.51	1949
2.5	0.64	1247
3.0	0.77	866

Cone Width (m)

Medium Beam
700mA using a 19° optic

Distance (m)	Cone Width (m)	Luminance (lx)
0.5	0.16	21352
1.0	0.32	5338
1.5	0.49	2372
2.0	0.65	1335
2.5	0.81	854
3.0	0.97	593

Cone Width (m)

Wide Beam
700mA using a 34° optic

Distance (m)	Cone Width (m)	Luminance (lx)
0.5	0.27	7672
1.0	0.54	1918
1.5	0.81	852
2.0	1.08	480
2.5	1.35	307
3.0	1.62	213

Cone Width (m)

Extra Wide Beam
700mA using a 55° optic

Distance (m)	Cone Width (m)	Luminance (lx)
0.5	0.46	3541
1.0	0.91	885
1.5	1.37	393
2.0	1.82	221
2.5	2.28	142
3.0	2.73	98

Cone Width (m)

Oval Beam
700mA using a 15° X 49° optic

Distance (m)	Cone Width (m)	Luminance (lx)
0.5	0.14 / 0.40	9371
1.0	0.28 / 0.80	2343
1.5	0.42 / 1.21	1041
2.0	0.56 / 1.61	586
2.5	0.69 / 2.01	375
3.0	0.83 / 2.41	260

Cone Width (m)

N1 LED Engine

Cone diagrams below are based on a 3000K N1 LED engine run at maximum output 700mA, 14W. Images below represents beam outputs when wall washing a 3m wall, spaced 125mm away from the lit surface. Photometric files (LDT) are included in the design pack which can be downloaded from the LD154 product page on the website.

Medium Spot Beam
700mA using a 25° optic

Distance (m)	Cone Width (m)	Luminance (lx)
0.5	0.21	17636
1.0	0.43	4409
1.5	0.64	1960
2.0	0.86	1102
2.5	1.07	705
3.0	1.29	490

Cone Width (m)

Medium Beam
700mA using a 35° optic

Distance (m)	Cone Width (m)	Luminance (lx)
0.5	0.27	9161
1.0	0.54	2290
1.5	0.81	1018
2.0	1.08	573
2.5	1.35	366
3.0	1.62	254

Cone Width (m)

Wide Beam
700mA using a 46° optic

Distance (m)	Cone Width (m)	Luminance (lx)
0.5	0.49	4778
1.0	0.98	1195
1.5	1.47	531
2.0	1.96	229
2.5	2.45	191
3.0	2.94	133

Cone Width (m)

Extra Wide Beam
700mA using a 65° optic

Distance (m)	Cone Width (m)	Luminance (lx)
0.5	0.55	3847
1.0	1.09	962
1.5	1.64	427
2.0	2.19	240
2.5	2.74	154
3.0	3.28	107

Cone Width (m)

Oval Beam
700mA using a 22° X 43° optic

Distance (m)	Cone Width (m)	Luminance (lx)
0.5	0.35 / 0.21	9989
1.0	0.70 / 0.42	2135
1.5	1.06 / 0.63	1110
2.0	1.41 / 0.84	624
2.5	1.76 / 1.04	400
3.0	2.11 / 1.25	277

Cone Width (m)

ORDER CODES & OPTIONS - LD1093Z

Example: LD1093Z-E3-700 / LW30 / MB / HC / POLISHED & PASSIVATED 316 STAINLESS STEEL / 493XPR

Light engine & drive current / LED Colour / Beam Angle / Accessory / Finish / Fixing

LD1093Z- / / / / / /





E3

LD1093Z (Trimless Zero bezel)	
	
5W LED at 350mA	LD1093Z-E3-350
7W LED at 500mA	LD1093Z-E3-500
10W LED at 700mA	LD1093Z-E3-700

Extra Warm White (2700K)	/LW27
Warm White (3000K)	/LW30
White (4000K) on request	/LW40
Cool White (5000K)	/LW50

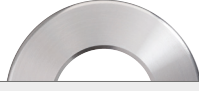
12° Narrow	/NB
19° Medium	/MB
34° Wide	/WB
55° Extra Wide	/WWB
15° x 49° Oval	/OB

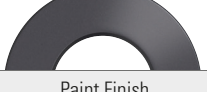
	/NGS
	/HL

	316 Stainless Steel
	Polished & Passivated 316 Stainless Steel (for marine environments)
	Paint Finish White (RAL 9016)
	Paint Finish Black (RAL 9005)
	Paint Finish Classic Bronze (YM262E)
	Paint Finish Textured Mars Bronze
	Paint Finish Textured Fir Green (RAL 6009)
	Paint Finish Gunmetal Grey (RAL 7021)
	Paint Finish - RAL







	/493XPR
	/493CMR
	/493SMS

N1

LD1093Z (Trimless Zero bezel)	
	
7W LED at 350mA	LD1093Z-N1-350
10W LED at 500mA	LD1093Z-N1-500
14W LED at 700mA	LD1093Z-N1-700

Super Warm White (2200K)	/LW22
Extra Warm White (2700K)	/LW27
Warm White (3000K)	/LW30
White (4000K) on request	/LW40
Cool White (5000K)	/LW50

25° Medium Spot	/MSB
35° Medium	/MB
46° Wide	/WB
65° Extra Wide	/WWB
22° x 43° Oval	/OB

	Paint Finish Black (RAL 9005)
	Paint Finish Classic Bronze (YM262E)
	Paint Finish Textured Mars Bronze
	Paint Finish Textured Fir Green (RAL 6009)
	Paint Finish Gunmetal Grey (RAL 7021)
	Paint Finish - RAL

Drivers
Use with 350mA, 500mA & 700mA constant current LED drivers We have a range of dimmable LED drivers DMX and DALI compatible. Please see the downloads section on our website.

ORDER CODES & OPTIONS - LD1093

Example: LD1093-E3-700 / LW30 / MB / HC / POLISHED & PASSIVATED 316 STAINLESS STEEL / 493XPR

Light engine & drive current / LED Colour / Beam Angle / Accessory / Finish / Fixing



E3



LD1093 (Trimmed bezel)	
	
5W LED at 350mA	LD1093-E3-350
7W LED at 500mA	LD1093-E3-500
10W LED at 700mA	LD1093-E3-700

Extra Warm White (2700K)	/LW27
Warm White (3000K)	/LW30
White (4000K) on request	/LW40
Cool White (5000K)	/LW50

12° Narrow	/NB
19° Medium	/MB
34° Wide	/WB
55° Extra Wide	/WWB
15° x 49° Oval	/OB

	/NGS
	/HL

	316 Stainless Steel
	Polished & Passivated 316 Stainless Steel (for marine environments)
	Paint Finish White (RAL 9016)







	/493XPR
	/SC
	/493S

N1

LD1093 (Trimmed bezel)	
	
7W LED at 350mA	LD1093-N1-350
10W LED at 500mA	LD1093-N1-500
14W LED at 700mA	LD1093-N1-700

Super Warm White (2200K)	/LW22
Extra Warm White (2700K)	/LW27
Warm White (3000K)	/LW30
White (4000K) on request	/LW40
Cool White (5000K)	/LW50

25° Medium Spot	/MSB
35° Medium	/MB
46° Wide	/WB
65° Extra Wide	/WWB
22° x 43° Oval	/OB

	Paint Finish Black (RAL 9005)
	Paint Finish Classic Bronze (YM262E)
	Paint Finish Textured Mars Bronze
	Paint Finish Textured Fir Green (RAL 6009)
	Paint Finish Gunmetal Grey (RAL 7021)
	Paint Finish - RAL

Drivers
Use with 350mA, 500mA & 700mA constant current LED drivers We have a range of dimmable LED drivers DMX and DALI compatible. Please see the downloads section on our website.