

LD20238
SURFACE MOUNTED ADJUSTABLE
LED SPOTLIGHT



The LD20238 is our most powerful LED spotlight to date with a lumen output of over 1400lm (P1 Engine) enabling it to reach heights of over 20 metres. The 50mm lens assembly coupled with a wide range of high efficiency LED engine options ensures a wide range of superior beams, including an ultra-narrow 9° beam (E3 Engine) with a peak intensity of 15,922cd, delivering exceptional performance for both indoor and outdoor lighting applications.

The fitting is fully customisable with multiple glare control options including oval and half-moon glare shields, a honeycomb louvre, and both full and half cowls. Along with a variety of flexible mounting solutions, including a ground spike, and surface mount base with lockable rotation and tilt, as well as discreet cable exit options. It is an ideal choice for architectural landscaping and façade lighting.

With a high ambient temperature tolerance of up to 50°C, the LD20238 excels in outdoor environments. It is IP67 rated and equipped with our Moisture Guard, and has been designed with a repairable engine, providing a robust circular solution for high-power spotlight applications.



KEY FEATURES

- > Utilises large 50mm low glare optics, chosen for efficiency, quality of beam and ability to produce narrow beams at high outputs
- > P1 engine with CREE COB delivering up to 1443lm at 700mA in 3000K
- > E3 engine with NICHIA LED delivering up to 699lm at 700mA in 3000K, offering an exceptional 9° extra narrow beam with peak intensity reaching 15,922cd
- > N1 engine with CREE COB delivering up to 1028lm at 700mA in 3000K, offering a 13° narrow beam
- > Selection of mounting options including the: surface mount base, mounting bracket, and surface mount ground spike
- > Deep recessed LED lens assembly with option of no cowl, full, or half anti-glare cowl and honeycomb louvre
- > Lockable head tilt adjustment
- > Machined aluminium fitting, paint finishes include: White (RAL 9016), Silver, Anthracite Grey (RAL 7016), Black (RAL 9005), Antique Bronze, Satin Antique Brass, Satin Brass or any RAL finish
- >  Contains our integral moisture guard (anti-wicking barrier), stopping water ingress from going up the cable into the product from incorrect IP-rated connections
- > Switched, 0-10V, Casambi, DMX, DALI or Mains dimmable drivers available

DIMENSIONS

For full dimensions please go to page 4.



WHITE LED ENGINE SPECIFICATION

Engine	E3			N1			P1	
Beam angles	9°, 11°, 22°, 29°, 42°, 53°, 10° x 56°			13°, 24°, 31°, 45°, 54°, 13° x 58°			20°, 27°, 33°, 47°, 58°, 19° x 60°	
LED manufacturer	NICHIA			CREE			CREE	
Colour temperature	2700K, 3000K, 4000K, 5000K			2200K, 2700K, 3000K, 4000K, 5000K			2200K, 2700K, 3000K, 4000K, 5000K	
Current [Rated Output]	350mA [5W]	500mA [7W]	700mA [10W]	350mA [7W]	500mA [10W]	700mA [14W]	350mA [14W]	500mA [20W]
Typical LED Circuit wattage	4.4W	6.4W	9.2W	6.4W	9.3W	13.3W	13.3W	19.6W
Delivered lumens (L ₁₀₀)*	418	557	699	557	776	1028	1050	1443
Delivered lm/Circuit W**	94	87	76	90	83	77	79	74
Typical LED Source wattage	4.0W	5.8W	8.3W	5.8W	8.4W	12.0W	12W	17.6W
Source LED lm	574	740	949	694	937	1264	1449	1983
Source lm/W	144	128	114	120	112	105	121	113
Forward voltage (V ₁₀₀)	11.3V	11.6V	11.8V	16.6V	16.8V	17.1V	34.3V	35.2V
CRI	85			93			93	
Colour consistency	2 SCDM			2 SCDM			2 SCDM	
Peak intensity	15,922 cd			13,809 cd			10,624 cd	
LOR	0.74			0.81			0.73	
TM30	RF86 RG98			RF91 RG100			RF90 RG97	
UGR rating ('downlight' mounted)	5.3	6.3	7.1	5.4	6.4	7.4	8	9.1
BUG rating ('downlight' mounted)	B1-U0-G0	B1-U0-G0	B1-U0-G0	B1-U0-G0	B1-U0-G0	B1-U0-G0	B1-U0-G0	B2-U0-G0
LED lifetime	L90B5 90000h							
Applications								

These values are based on LD20238-E3-700-LW30-ENB, LD20238-N1-700-LW30-NB and LD20238-P1-700-LW30-NB

*See lumen variance table to the right for N1 engine. E3 lumens apply across all colour temperatures

**LED wattage includes losses associated with using a 90% efficient driver

Lumen variance by CCT	
2200K	-7%
2700K	+/- 0%
4000K	+7%
5000K	+16%

MECHANICAL

Ambient temperature	E3	-20°C to 50°C (350mA/500mA/700mA)
	N1	-20°C to 50°C (350mA/500mA/700mA)
	P1	-20 to 50 (350mA) or -20 to 45 (500mA)
Glass	3mm thick toughened glass with black ceramic screen print	
Materials	Anodised aluminium body, with 316 stainless steel fixings	
Weight of product	Fitting (without any fixing methods)= 697.7 grams, SAM= 38.9 grammes, SMB= 104.96 grams, SGS= 80.08 grams	
IP rating	IP67	
IK rating	IK09	
Cable	Pre-wired 2 core exterior cable	
Wiring	In-series constant current wiring (pre-wired with 2 core cable at a length of 1m)	

ENVIRONMENTAL

TM65	Available on request	
TM66	2.5	
Repair + Refurbish		This product is included in our Repair and Refurbish scheme. This offers customers the ability to send back products to us for repair or refurbishment to extend their life without having to buy new fittings.

AVAILABLE FINISHES

Please refer to our finishes guide for full details

The LD20238 body is machined from aluminium and painted in-house at LightGraphix. Paint finishes are suitable for interior and exterior use on surface mounted products. Our standard colours are below, and we can accommodate any RAL request. Please view our full finishes guide online for more information.

WET SPRAY



BLACK
(RAL 9005)



WHITE
(RAL 9016)



SILVER ANODISED



ANTIQUE BRONZE



SATIN ANTIQUE BRASS



SATIN BRASS



ANTHRACITE GREY
(RAL 7016)



RAL COLOURS

POWDER COAT



TEXTURED MARS BRONZE



TEXTURED FIR GREEN
(RAL 6009)

ADJUSTABILITY

The LD20238 has a lockable tilt of -20° to $+105^{\circ}$ from horizontal (for all fixing options) and using the /SMB mounting method can be rotated 300° .

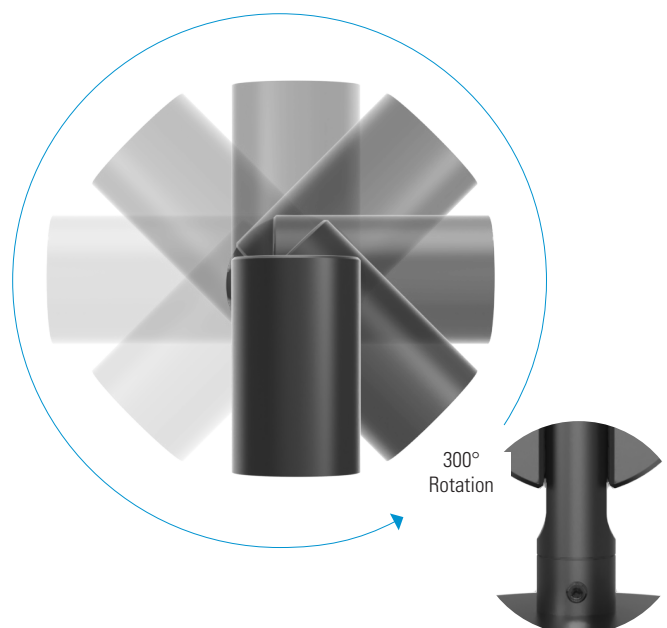

DIMENSIONS & FIXING OPTIONS

Dimensions in mm

/SMB Surface mount base

Surface mount base offers hidden wiring and a machined pivot arm with lockable tilt and rotation of the fitting. Cable length: 1000mm Weight: 0.11kg

/SAM Surface adjustable mount

Surface adjustable mounting is screwed to the surface via a strong mounting stand which allows for minor rotational adjustment. The fitting tilt adjustment is lockable via the socket head screw located on the side. Cable length: 1000mm Weight: 0.04kg

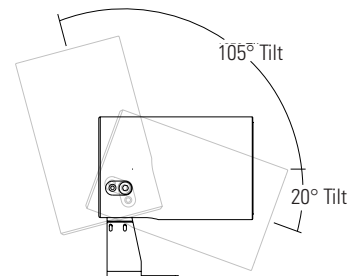
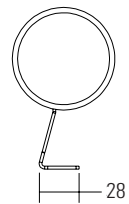
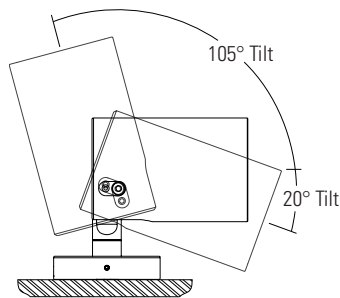
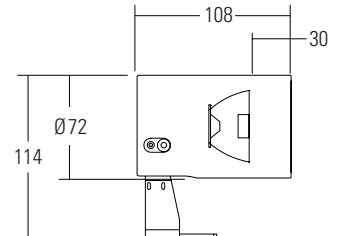
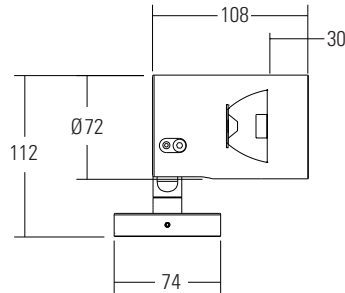

/SMB Cable mounting option

There are two cable exit hole options when specifying a surface mount base. This includes the cable remaining hidden within the base of the fixing and entering through the mounting surface below. Or using the horizontal exit hole on the side of the base, if the cable is not able to pass directly through its mounting surface

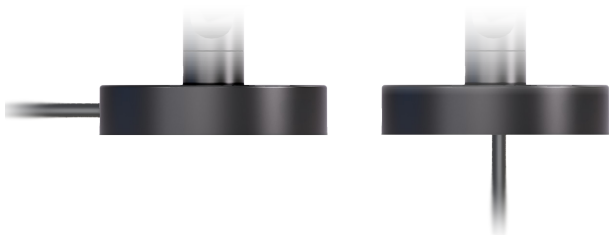

/SGS Surface ground spike

Surface level ground spike with lockable tilting adjustment. Cable length: 1000mm Weight: 0.08kg

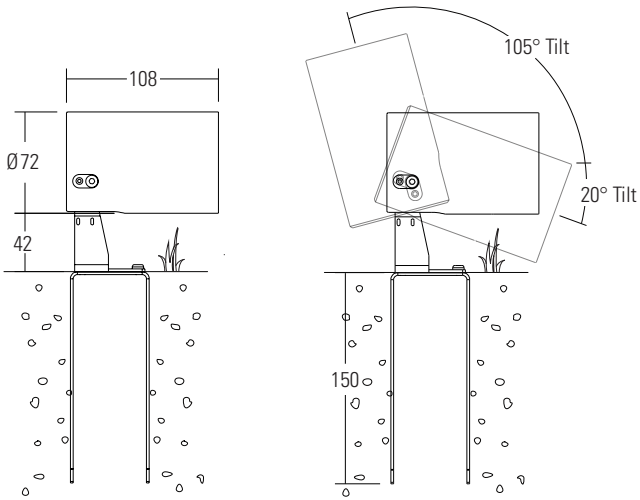

GLARE CONTROL OPTIONS

/NC No Cowl

The LD20238 has been designed with optics recessed 25mm into the body for low glare and is suitable for use without a cowl.

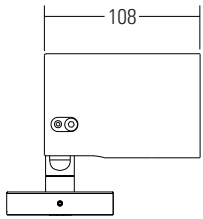

/HC Anti-glare half cowl

The half cowl can be rotated in any direction to further reduce glare.

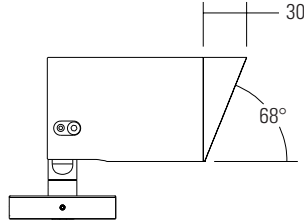

/FC Anti-glare full cowl

A full cowl will reduce glare from all angles.

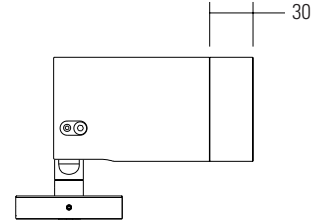

/NGS No glare shield

For when no additional glare control is required.

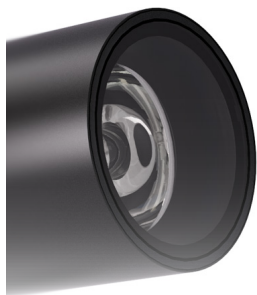

/GS20238 Glare shield

Half-moon glare shield for applications that require very low glare. Lumen output is typically reduced by 60% with no light lost on the lit surface.

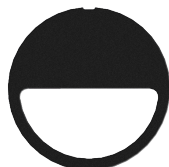
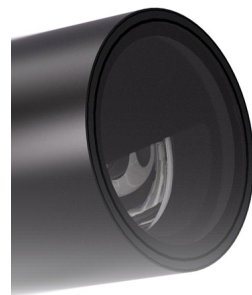

/GSOB20238 Oval beam glare shield

Reduces the angles at which glare is visible without compromising the oval output of the beam. Useful when used in applications where glare can be seen from two sides, for example archways.

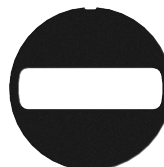

/HL54 Honeycomb louvre

Helps reduce glare from all angles and can be used with glare shields.

Please note this is not suitable for use with the 14° x 48° oval beam. Suitable for use with an anti-glare cowl.

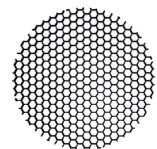

CONE DIAGRAMS

E3 LED Engine

Cone diagrams below are based on a 3000K E3 LED engine run at maximum output 700mA, 10W. Images below represent beam outputs when wall washing a 3m wall, spaced 125mm away from the lit surface. Photometric files (LDT) are included in the design pack which can be downloaded from the LD20238 product page on the website.

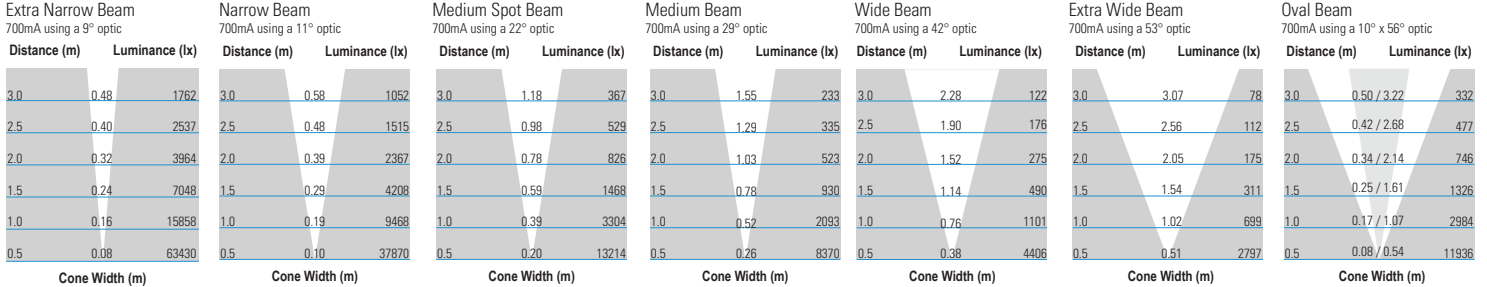

N1 LED Engine

Cone diagrams below are based on a 3000K N1 LED engine run at maximum output 700mA, 14W. Images below represents beam outputs when wall washing a 3m wall, spaced 125mm away from the lit surface. Photometric files (LDT) are included in the design pack which can be downloaded from the LD20238 product page on the website.

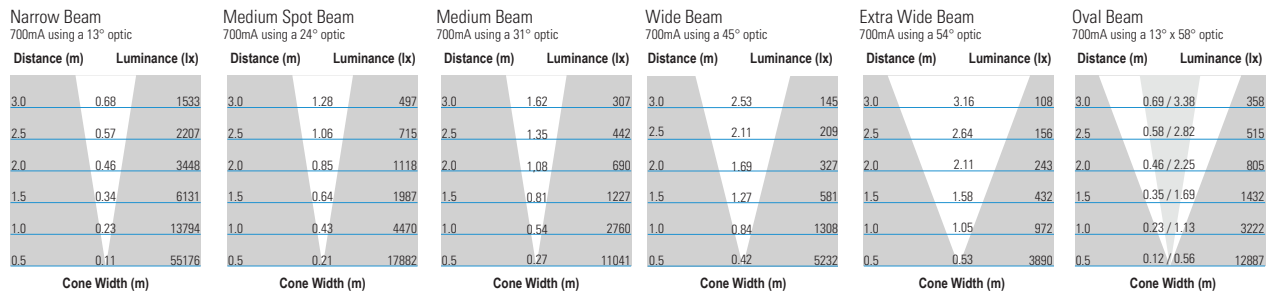

P1 LED Engine

Cone diagrams below are based on a 3000K P1 LED engine run at maximum output 500mA, 20W. Images below represents beam outputs when wall washing a 3m wall, spaced 125mm away from the lit surface. Photometric files (LDT) are included in the design pack which can be downloaded from the LD20238 product page on the website.

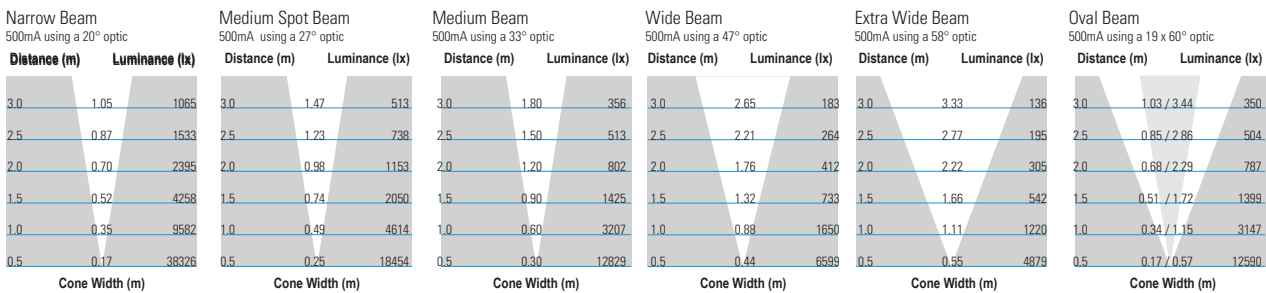

ORDER CODES & OPTIONS

Example: LD238-E3-700 / LW30 / OB / HC / HL / WS Black / SAM

Light engine & drive current	LED Colour	Beam Angle	Accessory	Finish	Fixing
LD20238-	/	/	/	/	/



E3



5W LED at 350mA	LD20238-E3-350
7W LED at 500mA	LD20238-E3-500
10W LED at 700mA	LD20238-E3-700

Extra Warm White (2700K)	/LW27
Warm White (3000K)	/LW30
White (4000K) on request	/LW40
Cool White (5000K)	/LW50

9° Extra Narrow	/ENB
11° Narrow	/NB
22° Medium Spot	/MSB
29° Medium	/MB
42° Wide	/WB
53° Extra Wide	/WWB
10° x 56° Oval	/OB

	/NC
	/HC
	/FC
	/NGS
	/GSHM20238
	/GSOB20238
	/HL54

	WET SPRAY Black (RAL 9005)
	WET SPRAY White (RAL 9016)
	WET SPRAY Silver Anodised
	WET SPRAY Antique Bronze
	WET SPRAY Satin Antique Brass
	WET SPRAY Satin Brass
	WET SPRAY Anthracite Grey (RAL 7016)
	WET SPRAY RAL Colours
	POWDER COAT Textured Mars Bronze
	POWDER COAT Textured Fir Green (RAL 6009)

	/SMB
	/SAM
	/SGS

N1

7W LED at 350mA	LD20238-N1-350
10W LED at 500mA	LD20238-N1-500
14W LED at 700mA	LD20238-N1-700

Super Warm White (2200K)	/LW22
Extra Warm White (2700K)	/LW27
Warm White (3000K)	/LW30
White (4000K) on request	/LW40
Cool White (5000K)	/LW50

13° Narrow	/NB
24° Medium Spot	/MSB
31° Medium	/MB
45° Wide	/WB
54° Extra Wide	/WWB
13° x 58° Oval	/OB

P1

14W LED at 350mA	LD20238-P1-350
20W LED at 500mA	LD20238-P1-500

Super Warm White (2200K)	/LW22
Extra Warm White (2700K)	/LW27
Warm White (3000K)	/LW30
White (4000K) on request	/LW40
Cool White (5000K)	/LW50

20° Narrow	/NB
27° Medium Spot	/MSB
33° Medium	/MB
47° Wide	/WB
58° Extra Wide	/WWB
19° x 60° Oval	/OB

Drivers
Use with 350mA, 500mA & 700mA constant current LED drivers We have a range of dimmable LED drivers DMX and DALI compatible. Please see the downloads section on our website.