

LD10237

HIGH-POWER SURFACE MOUNTED WALL WASHER



The LD10237 is a powerful interior and exterior, surface mounted product, designed for wall washing applications, that dependant on its chosen orientation, can illuminate the surface up or downwards. It can be specified with a wide range of options allowing it to suit most project requirements. Available LED engines include E2, Tunable White, CLR, RGBW and F1 which offer a range of colour temperatures between 2200K-5000K, with multiple beam angles to choose from. The LD10237 body is a machined billet of aluminium offering a robust and minimal design in numerous paint finishes with discreet fixing options available. Low glare illumination has been achieved by recessing the LED into the body, which is then held in place by anti-glare rings. This is a very tough, high quality fitting, machined from high grade materials, ensuring excellent thermal and light output performance.

KEY FEATURES

- > E2 engine featuring the CREE LED delivering up to 601 lumens with 2-step binning and built in reverse polarity protection
- > Available with F1, RGBW, CLR and Tunable White LED engines and optional 2nd channel LEDs for secondary lighting applications
- > Range of beam angles featuring a narrow 10° spot for lighting columns and arches, or a 15°x 49° spreader lens, which is ideal for wall washing applications
- > Single light source and optic produces a very consistent beam with no multiple shadows
- > LED and lens set back in a matt black anodised body for reduced glare
- > Body is a machined solid billet of aluminium
- > Paint finishes include: White (RAL 9016), Silver, Anthracite Grey (RAL 7016), Black (RAL 9005), Antique Bronze, Satin Antique Brass, Satin Brass or any RAL finish
- > Discreet fixing with two grub screws behind the body
- > Available with Switched, 0-10V, Casambi, DMX, Dali or Mains dimmable drivers

DIMENSIONS

Dimensions in mm

For fitting and accessory dimensions please go to page 4.



WHITE LED ENGINE SPECIFICATION

Engine	E2			F1		
Beam angles	10°, 19°, 34°, 54°, 15°x 49°			25°, 46°, 65°, 43° x 25°		
LED manufacturer	CREE			CREE		
Colour temperature*	2700K / 3000K / 4000K / 5000K			2200K		
Current	350mA	500mA	700mA	350mA	500mA	700mA
LED power (Max)	4.2W (5W**)	6W (7W**)	8.4W (10W**)	3.2W (3.5W**)	4.5W (5W**)	6.3W (7W**)
Delivered lumens (L ₁₀₀)	392	474	601	227	241	367
Lumens per circuit watt	79	68	60	65	49	52
CRI (Min)	85+			90+		
Forward voltage (V ₁₀₀)	14V			9V		
Colour consistency	2 SCDM			3 SCDM		
Peak intensity	7851 cd			1641 cd		
LED lumens	873			623		
LOR	0.68			0.63		
TM30	RF85	RG98		RF90	RG103	
UGR***	12.5			8.1		
LED lifetime	L90B5 at 90,000hrs					
Applications						

These values are based around a LD10237-E2-700-LW30-NB & LD10237-F1-700-LW22-MSB

*see lumen variance table to the right

**indicates the nominal power for the LED run at that particular current and includes losses associated with using an 85% efficient driver



***UGR values based on room parameters of 4H 8H, C70 W50 F20

Lumen variance by CCT	
2700K	+/- 0%
4000K	+7%
5000K	+16%

MECHANICAL

Ambient temperature	-20° to 45° (500mA) or -20° to 35° (700mA)
Glass	Low iron glass 3mm thick
Materials	Anodised aluminium body, with stainless steel fixing brackets
Weight of product	1kg
IP rating	IP67
IK rating	IK08
Wiring	In-series constant current wiring (pre-wired with 2 core cable at a length of 1m)

COLOUR & DYNAMIC LED ENGINE SPECIFICATION

Engine	 CLR - Colour	 RGBW	 TW - Tunable White
Beam Angles	24°, 38°, 54°, 20° x 46°	38° colour mix lens	24°, 38°, 54°, 20° x 46°
LED manufacturer	CREE	CREE	CREE
Colour temperature	Red, Green, Blue, Amber	Red, Green, Blue, 4000K White	Warm White 2700K or 3000K Cool White 4000K or 5000K
Current	500mA	350mA 500mA	500mA
LED power (Max)	7W	3.5W 5W	6.3W (7W*) 3.5W per channel
Applications			

MECHANICAL

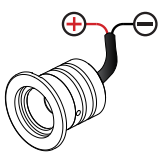
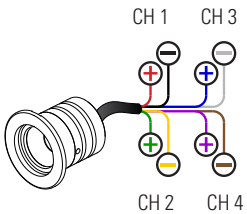
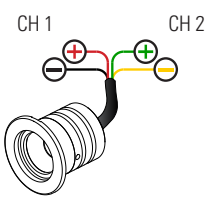
Glass	Low iron glass 3mm thick		
Materials	Anodised aluminium body, with stainless steel fixing brackets		
Weight of product	1kg		
IP rating	IP67		
IK rating	IK08		
Wiring	<p>CLR - 2 core cables at 1m in length</p> 	<p>RGBW - 8 core cables at 1m in length</p> 	<p>TW - 4 core cables at 1m in length</p> 

AVAILABLE FINISHES

Please refer to our finishes guide for full details

The LD10237 body is a machined single billet of aluminium and is painted in-house at LightGraphix. Paint finishes are suitable for interior and exterior use on surface mounted products. Our standard colours are below but we can accommodate any RAL request.



SILVER ANODISED



ANTIQUÉ BRONZE



SATIN ANTIQUÉ BRASS



SATIN BRASS



BLACK (RAL 9005)



ANTHRACITE GREY (RAL 7016)



WHITE (RAL 9016)

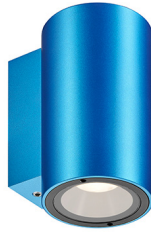

RAL

DIMENSIONS

Dimensions in mm

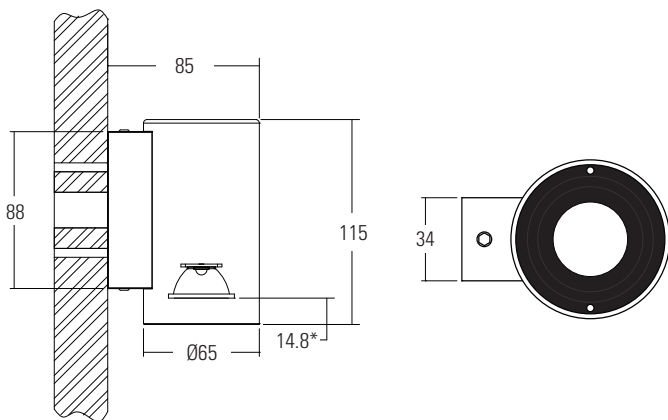

* 4.3mm when using the taller RGBW optic



Design: Lighting Design International
Project: Four Seasons Astir-Palace Hotel, Athens
Product: LD10237
Photography: Gavril (www.gavrilux.com)

CONE DIAGRAMS

E2

Cone diagrams below are based on a 3000K E2 LED engine run at maximum output 700mA, 10W. Images below represents beam outputs when wall washing a 3m wall, spaced 125mm away from the lit surface. Photometric files (LDT) are included in the design pack which can be downloaded from the LD10237 product page on the website.

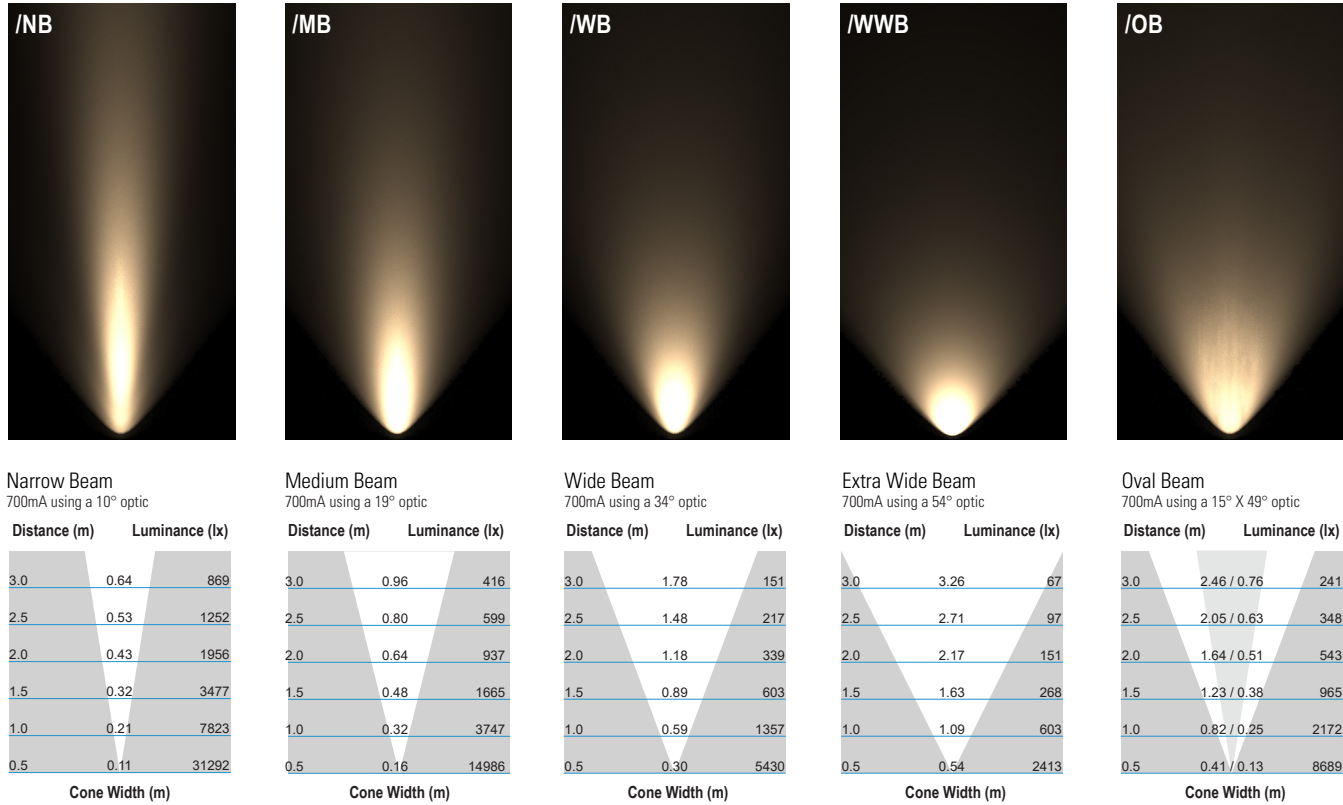

F1

Cone diagrams below are based on a 2200K F1 LED engine run at maximum output 700mA, 7W. Images below represents beam outputs when wall washing a 3m wall, spaced 125mm away from the lit surface. Photometric files (LDT) are included in the design pack which can be downloaded from the LD10237 product page on the website.

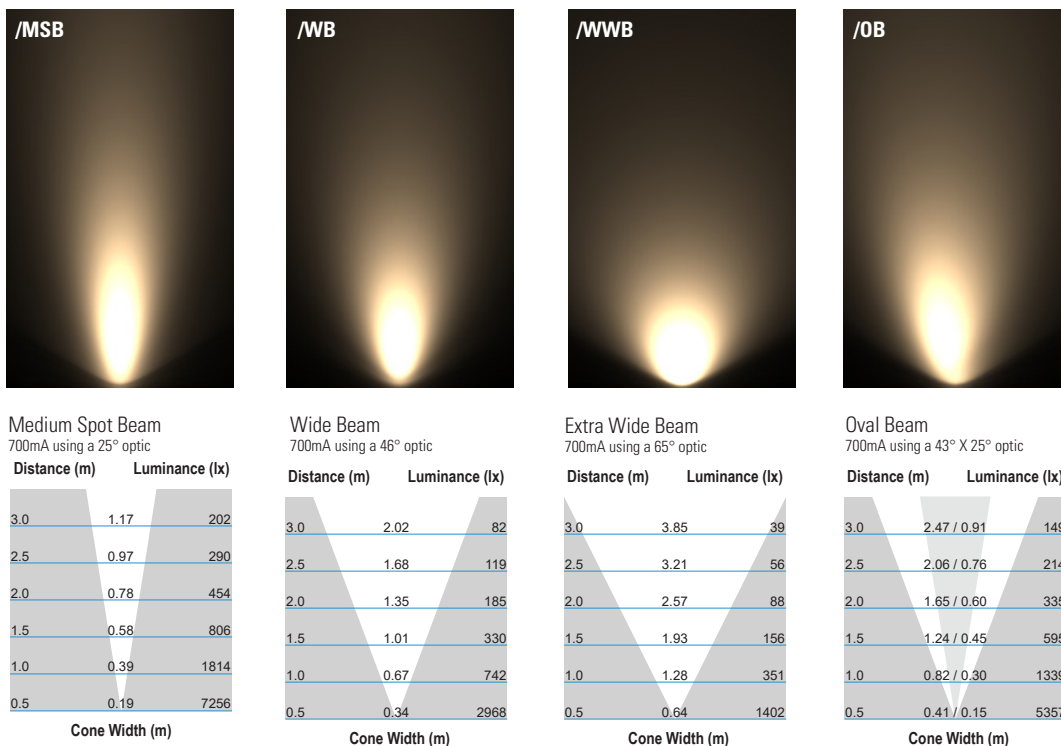

ORDER CODES & OPTIONS

Example: LD10237-E2-500 / LW30 / NB / Silver Anodized

Light Engine & Drive Current	/	LED Colour	/	Beam angle	/	Finish
LD10237 -	/		/		/	

WHITE LED ENGINES

 E2

5W LED at 350mA	LD10237-E2-350
7W LED at 500mA	LD10237-E2-500
10W LED at 700mA	LD10237-E2-700

Extra Warm White (2700K)	/LW27
Warm White (3000K)	/LW30
White (4000K) - on request	/LW40
Cool White (5000K)	/LW50

10° Narrow spot	/NB
19° Medium	/MB
34° Wide	/WB
54° Extra wide	/WWB
15° x 49° Oval	/OB



 F1

3.5W LED at 350mA	LD10237-F1-350
5W LED at 500mA	LD10237-F1-500
7W LED at 700mA	LD10237-F1-700

Super Warm White (2200K)	/LW22
--------------------------	-------

25° Medium spot	/MSB
46° Wide	/WB
65° Extra wide	/WWB
43° x 25° Oval	/OB



COLOUR & DYNAMIC LED ENGINES

 CLR

3.5W LED at 350mA	LD10237-CLR-350
-------------------	-----------------

Red	/LR
Green	/LG
Blue	/LB
Amber	/LA

24° Medium	/MB
38° Wide	/WB
54° Extra wide	/WWB
20° x 46° Oval	/OB



 RGBW

3.5W LED at 350mA	LD10237-RGBW-350
5W LED at 500mA	LD10237-RGBW-500

38° Colour mix lens



 TW

3.5W LED at 350mA	LD10237-TW-350
-------------------	----------------

Tunable White 2700K & 4000K (standard option)	/LW27 + LW40
Tunable White 2700K & 5000K	/LW27 + LW50
Custom	/LW** + L**

24° Medium	/MB
38° Wide	/WB
54° Extra wide	/WWB
20° x 46° Oval	/OB



Drivers
Use with 350mA, 500mA & 700mA constant current LED drivers
We have a range of dimmable LED drivers DMX and DALI compatible. Please see the downloads section on our website.