

LD242A

Underwater LED Pool Light



Data sheet - Page 1



Project: Sea Containers House, London Product: LD242A

The LD242A has been designed specifically for permanent submersion applications. It is manufactured from high grade 316 stainless steel and anodised aluminium. The LED module is potted to prevent moisture ingress via the cable and the fitting is mechanically sealed. The bezel is polished and passivated for extra protection against chlorine or salt water.

Key Features

- Integral anti-wicking barrier increases protection against moisture ingress due to incorrect IP rated cable connections
- LD242A is mechanically sealed, allowing it to be a serviceable product by LightGraphix
- Excellent diffused beam shape from a range of optics
- New optional glare shield accessory
- Typical 93 CRI in 3000K warm white
- Reverse polarity protection
- First fix sleeve and O-rings to seal fitting into mounting surface
- Optional concrete-in first fix housing
- Bezel is polished and passivated for pool and sea environments
- LD242A RGB also available
- Please specify with long cables to enable connections to be made in a dry location
- Available with 0-10V, DMX, DALI or Mains dimmable drivers

Specification

Applications



Beam Angles

12°, 31°, 48°, 12° x 36°

LED type

1 x C1 Engine with NICHIA LED

Colour temperature

2200K / 2700K / 3000K / 4000K** / 5000K

Current

350

500

700

LED power (W)*

1.2W

1.7W

2.4W

CRI (Min)

93

93

93

Forward voltage (V)₁₀₀

3.0V

3.2V

3.4V

Delivered lumens (L₁₀₀)**

103

134

174

Lumens per circuit watt

86

79

73

LED lifetime

L90B5 at 90,000hrs

Glass

5mm thick low iron glass

Materials

Hard black anodised aluminium body, machine finish 316 stainless steel bezel

Wiring

Comes pre-wired with 2 core 1m lead, can be specified with up to 10m at extra cost

IP rating

IP68 up to 2m - not suitable for saltwater pools

*LED wattage includes losses associated with using an 85% efficient driver

**Lumen output data applies to all colour temperatures.



LD242A

Underwater LED Pool Light



Data sheet - Page 2

Product Features

BEZEL

High quality machined, marine-grade 316 stainless steel, which is polished and passivated to provide extra protection in underwater environments. Polishing the bezel brings the chromium to the surface and gives excellent protection from oxidation, whilst passivation removes ferrous material from details like threads and prevents brown stains caused by oxidation.



WATERTIGHTNESS

LD242A is mechanically sealed with O-rings, increasing both the reliability and serviceability of the fitting.

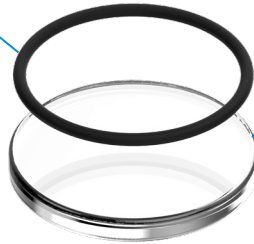

GLASS

5mm thick low iron glass, for high efficiency light output.

GLARE SHIELD

Optional glare shield for reduced glare.



OPTIC

High efficiency optics with a range of beam angles to create the perfect effect.

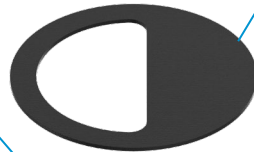

OPTIC HOLDER

Matt black anodising reduces glare from internal surfaces.

LED

Cree XPG2 with on-board reverse polarity protection.



BODY

Machined and anodised body. 6000 series aluminium chosen for its thermal characteristics and resistance to corrosion.

ACCESSORY

Choose between our fixing sleeve or concrete-in housing



LD242A

Underwater LED Pool Light



Data sheet - Page 3

Glare Shield



/GS - Glare Shield

For reduced glare applications, a half-moon glare shield can be specified.

Covering 45% of the lit surface of the optic behind it, without being too disruptive to the beam output.

Please note that this option is not available for the oval beam lens.

LED Technology

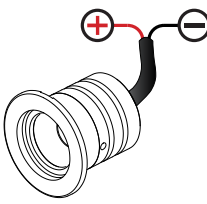
LED Board		Industry leading thermal management of the LED, with a high quality, embedded copper PCB and direct contact cooling for the LEDs, guaranteeing long life and minimal colour shift.
LED type	Cree XPG2	
Key features	<ul style="list-style-type: none"> - Available in a range of whites: 2700K, 3000K, 4000K and 5000K - Individual colours: red, green, blue and amber - 2 step binning - On-board polarity protection - All copper LED board for increased thermal transfer 	
Cables		

LD242A

Underwater LED Pool Light

Data sheet - Page 4



Dimensions and Fixing Options

/476 - Fixing sleeve and O-rings

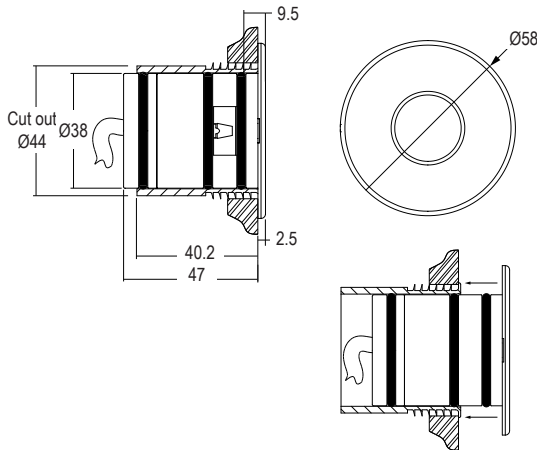

/242N - Concrete housing

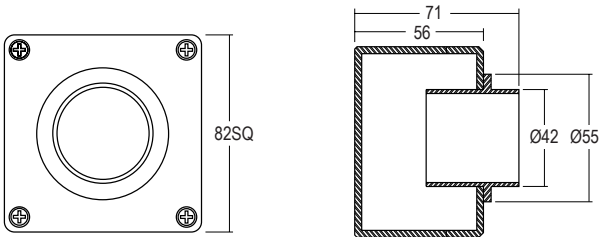

(Dimensions in mm)

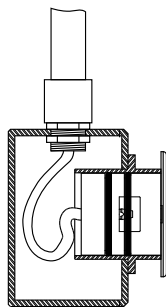

IP rated conduit bonded to housing. It is recommended to specify LD242A with a long cable to enable connections to be made in a dry location. No connection should be made within the concrete housing.

Order Codes and Options

Product code	LED colour	Beam angle	Glare shield	Finish	Fixing
LD242A-C1 - 350 - 500 - 701	<input type="text"/>	<input type="text"/>	<input type="text"/>	<input type="text"/>	<input type="text"/>
Example: LD242A-C1-700 / LW30 / MB / GS / Stainless Steel / 476					

Product codes with output options

1.2W LED at 350mA	LD242A-C1-350
1.7W LED at 500mA	LD242A-C1-500
2.4W LED at 700mA	LD242A-C1-700

LED colour options

LED colour options	Suffix
Extra Warm White (2700K)	/LW27
Warm White (3000K)	/LW30
White (4000K) - on request	/LW40
Cool White (5000K)	/LW50
Red	/LR
Blue	/LB
Green	/LG
Amber	/LA

*Other LED colour temperatures are available. Please speak to a member of our sales team.

Beam / lens angle options

12° narrow spot	/NB
31° medium	/MB
48° wide	/WB
12° x 36° oval (GS not available with this optic)	/OB

Glare shield

Half-moon glare shield	/GS
------------------------	-----

Bezel finish options

Polished and passivated stainless steel (for marine environments)

Fixing accessories

First fix sleeve with O-rings	/476
Concrete housing	/242N

Use with 350mA, 500mA & 700mA constant current LED drivers

We have a wide range of dimmable LED drivers, 0-10V, DMX, DALI and Mains dimmable. Please see the downloads section on our website:

To run 1-14 LD242A-C1-350 in series use a TXDEL350D (0-10V dimmable)

To run 1-14 LD242A-C1-500 in series use a TXDEL500D (0-10V dimmable)

To run 1-13 LD242A-C1-700 in series use a TXDEL700D (0-10V dimmable)