

## LD42

### LOW GLARE MINIATURE RECESSED INTERIOR/EXTERIOR LED WALL LIGHT



CB | RLE | R+R



The LD42 fitting is a miniature recessed LED wall light, ideal for discreet lighting of steps and pathways in interior, exterior and marine applications. The lens assembly is recessed 10mm within the body for low glare, which can be further reduced with a unique combination of glare shield and tilt lens options to suit individual application requirements. This includes aperture reductions of 45% or 70%, with or without an integral 20° Tilt lens, which focuses the light onto the lit surface for a concentrated lit effect. For a miniature fitting, LD42 produces an excellent throw of light when more output is required and with a high IP rating, is ideal for use in the harshest of environments. When used with our LD43 uplight, a uniform floor and wall washing effect can be achieved.

## KEY FEATURES

- > High-power C1 engine with NICHIA LED delivering up to 134lm
- > Miniature fitting with very minimal body depth and bezel diameter
- > Available with a 45% or 70% glare shield accessory
- > Optional 20° Tilt lens angles the light onto the lit surface for a more concentrated effect
- > Wide range of high-quality machined metal and painted bezel finishes available, including: 316 Stainless Steel, Polished & Passivated 316 Stainless Steel, Machined Brass, Flamed Solid Bronze, White (RAL 9016), Black (RAL 9005), Antique Bronze, Satin Antique Brass, Satin Brass, Anthracite Grey (RAL 7016) and any RAL
- > High efficiency optics produce excellent beam spread and shape
- > LED recessed 10mm within the body for reduced glare
- > Glass fixed with hidden gasket means no unsightly glue line
- > Hidden fixing options include spring clips or /480 first fix sleeve with O-rings
- > Switched, 0-10V, Casambi, DMX, DALI or Mains dimmable drivers available



## DIMENSIONS

Dimensions in mm

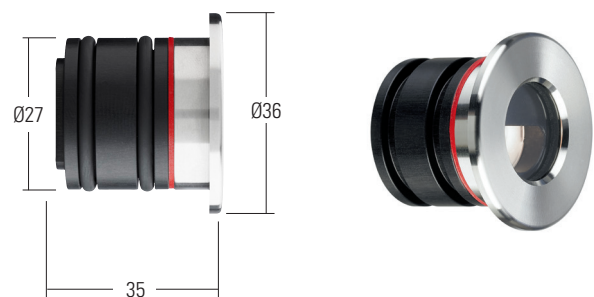
For fixing dimensions please go to page 3.



## WHITE LED ENGINE SPECIFICATION

Engine	 C1	
Beam angles	12°, 31°, 48°, 12° x 36°	
LED manufacturer	NICHIA	
Colour temperature	2200K / 2700K / 3000K / 4000K / 5000K	
Current [Rated output]	350mA [1.2W]	500mA [1.7W]
Typical LED Circuit wattage	1.1W	1.6W
Delivered lumens (L <sub>100</sub> )*	103	134
Delivered lm/Circuit W**	95	83
Typical LED Source wattage	1W	1.5W
Source LED Lm	133	187
Source lm/W	136	129
Forward voltage (V <sub>100</sub> )	2.8V	2.9V
CRI	93	
Colour consistency	2 SCDM	
Peak intensity	1,057 cd	
LOR	0.72	
TM30	RF93   RG100	
UGR	UGR unavailable for wall mounted fittings	
BUG rating (Sideways mounted)	B0-U2-G1	
LED lifetime	L90B5 at 90,000hrs	
Applications		

This data is based on LD42-C1-500-LW30-NB

\*Lumen output data applies to all colour temperatures



\*\*LED wattage includes losses associated with using a 90% efficient driver

## MECHANICAL

Ambient temperature	-20° to 45° (350mA) or -20° to 35° (500mA)
Glass	3.3mm thick borosilicate
Materials	Hard anodised aluminium body with machined 316 stainless steel bezel
IP rating	IP68 - not suitable for permanent submersion
Wiring	In-series constant current wiring (pre-wired with 2 x single core cable at a length of 150mm*)

\*Extendable cables available up to 2M. For longer cables see the LD44Y

## ENVIRONMENTAL

TM65	Available on request
TM66	2.7
Repair + Refurbish	 This product is included in our Repair and Refurbish scheme. This offers customers the ability to send back products to us for repair or refurbishment to extend their life without having to buy new fittings.
RLE (REPLACEABLE LIGHT ENGINE)	 Visit page 5 for replacement parts

AVAILABLE FINISHES

Please refer to our finishes guide for full details



316 STAINLESS STEEL

- > Marine grade 316 Steel
- > Standard machined finish
- > Extremely durable
- > Passivation recommended for marine environments to prevent corrosion and build up of brown stains caused by oxidation
- > Interior & exterior use



POLISHED & PASSIVATED  
316 STAINLESS STEEL

- > Marine Grade 316 Steel
- > Mirror like finish
- > Extremely durable
- > Passivated to extensively prolong resistance to corrosion and brown stains caused by oxidation in marine environments
- > Interior & exterior use



MACHINED BRASS

- > Solid CZ121 Brass
- > Standard machined finish
- > Corrosion resistance rated fair to excellent
- > Please note a natural green/brown patination layer will form after long term exposure to the elements, the extent of this discolouration will be dependant on its location.
- > Interior & exterior use



FLAMED SOLID BRONZE

- > Solid Bronze
- > Hand finished Flamed Bronze unique to LightGraphix
- > Extremely durable with very high corrosion resistance
- > Please note a natural dark patination layer will form after long term exposure to the elements, the extent of this discolouration will be dependant on its location.
- > Interior & exterior use



PAINT FINISH - WET SPRAY

- > White (RAL 9016), Black (RAL 9005), Antique Bronze, Satin Antique Brass, Satin Brass, Anthracite Grey (7016) or any RAL colour available
- > Not recommended for footlights in high traffic areas
- > Interior & exterior use

DIMENSIONS AND FIXING ACCESSORIES

Dimensions in mm

/480 O-rings and sleeve

Robust, watertight method of fixing.

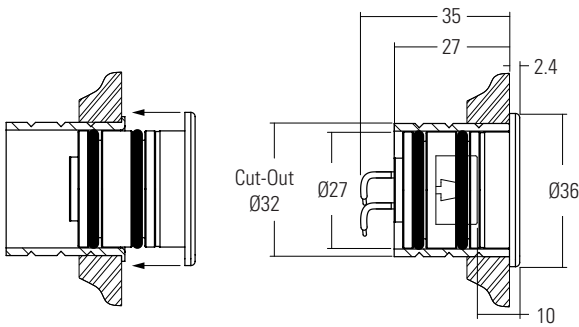

/SC Spring clip fixing

Provide a simple single-fix mounting method.

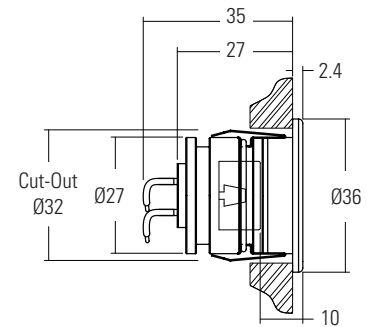

Design: DPA Lighting Project: The Langley Hotel, Buckinghamshire, UK Product: LD42 with GS44-45

## GLARE CONTROL AND LIGHT OUTPUT OPTIONS

### LD42

Circular aperture with lens and LED assembly recessed into the body by 10mm.

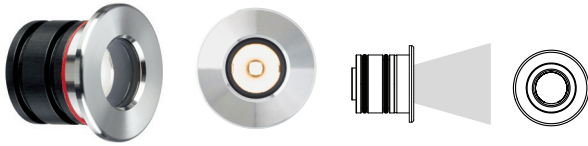

### LD42 with GS44-45

Addition of a half-moon glare shield in front of the lens to further reduce glare. Please note that the Oval beam cannot be used with GS44-45.



### LD42 with Tilt lens and GS44-45

Features a half-moon glare shield, but with the addition of an integral 20° Tilt lens which angles the light towards the lit surface. Please note that the Oval beam cannot be used with Tilt lens and GS44-45.

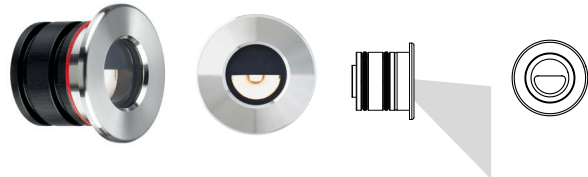

### LD42 with GS44-70

Features a 70% glare shield for applications that require minimal output and glare. Please note that the Oval beam cannot be used with the GS44-70.

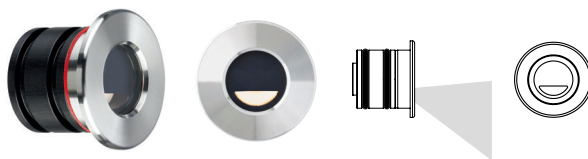

### LD42 with Tilt lens and GS44-70

Features a 70% glare shield, but with the addition of an integral 20° Tilt lens which angles the light towards the lit surface. Please note this option is only available in a Narrow beam.

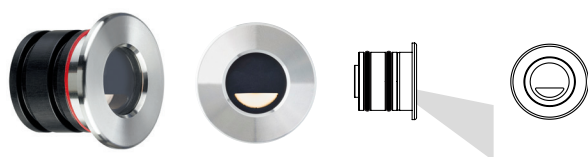

Product: LD42 with GS44-45  
Project: Private residence  
Design: Sian Baxter Lighting Design

## RLE - REPLACEABLE LIGHT ENGINES



### What is RLE

On the surface, RLE is LightGraphix's answer to the Circular economy question that is facing many industries at the moment. However for us, RLE is an ethos; a commitment that LightGraphix will factor in the principles of good circular design into all of its future product design. It allows us to offer luminaires that contain replaceable, energy-efficient light engines. This gives customers the ability to refurbish existing lighting installations rather than having to replace the entire luminaire. This will fall into two types of refurbishments: replaceable, and repairable.

### RLE Engines

Repairs can be conducted on any site worldwide, or in our factory, with a small tool. Simply swap out the singular modular LED insert, and replace it with another, along with a new optic, which are both supplied by us. The warranty provided with the product varies based on who is performing RLE repairs. There are three types of RLE engine, categorised based on the size of the product. RLE1 is the smallest, with RLE3 being the largest.



Used in the following products:  
LD42, LD42D, LD43 & LD43G

## LD42 RLE REPLACEMENT PARTS

Please use the configurator below to specify your replacement engine and optic. If you are unsure of your original specifications, please check the label on your LightGraphix fitting, or get in touch with our sales team. Installation sheets will be supplied with the new components.

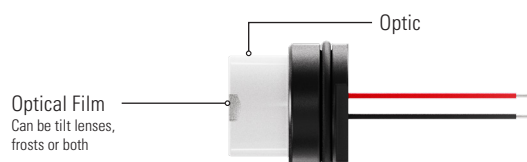

RLE Engine		LED Colour		Beam Angle		Accessories	
<input type="text"/>		<input type="text"/>		<input type="text"/>		<input type="text"/>	
RLE 2 ENGINE	RLE2/	Super Warm White (2200K)	/LW22	Narrow beam 16mm optic	RLE/OP-16/NB	Optical Filter / Tilt Lens 1	RLE/OF/TL1
		Extra Warm White (2700K)	/LW27	Medium beam 16mm optic	RLE/OP-16/MB		
		Warm White (3000K)	/LW30	Wide beam 16mm optic	RLE/OP-16/WB		
		White (4000K) - on request	/LW40	Oval beam 16mm optic	RLE/OP-16/OB		
		Cool White (5000K)	/LW50				







ORDER CODES & OPTIONS - LD42

Example: LD42-C1-500 / LW30 / NB / L / GS44-45 / 316 STAINLESS STEEL / SC

Light engine & drive current / LED colour / Beam angle / Optical option / Glare shield / Finish / Fixing

LD42- / / / / / / /

**C1**

1.2W LED at 350mA	LD42-C1-350	Super Warm White (2200K) /LW22	12° Narrow /NB	20° Tilt A			
1.7W LED at 500mA	LD42-C1-500	Extra Warm White (2700K) /LW27	31° Medium /MB	No tilt L		Polished & Passivated 316 Stainless Steel (for marine environments)	
		Warm White (3000K) /LW30	48° Wide /WB	*When using Tilt lens, only Narrow beam can be specified)		GS44-45 (not applicable with Oval beam)	Machined Brass
		White (4000K) - on request /LW40	12° x 36° Oval /OB			Flamed Solid Bronze	
		Cool White (5000K) /LW50				WET SPRAY Antique Bronze	
		Red /LR				WET SPRAY Satin Antique Brass	
		Green /LG				WET SPRAY Satin Brass	
		Blue /LB				WET SPRAY Black (RAL 9005)	
		Amber /LA				WET SPRAY Anthracite Grey (RAL 7016)	
						WET SPRAY White (RAL 9016)	
						WET SPRAY RAL	

**Drivers**  
Use with 350mA and 500mA constant current LED drivers  
We have a range of dimmable LED drivers including DMX and DALI compatible. Please see the downloads section on our website.