

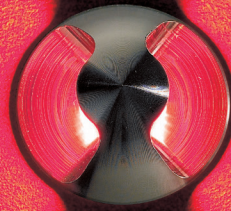

LD65 MINIATURE IN GROUND LED PATH MARKER



The LD65 is a miniature in-ground LED surface washer that uses a specially designed reflector to produce 2 x 120° angles of illumination. It is manufactured from a single billet of 316 stainless steel making it extremely robust. It is useful for a wide range of applications including steps and pathways and can be used on interior or exterior walls to create interesting effects. With no visible fixings they can be secured either by O-rings and a first fix sleeve, or a ground tube.



KEY FEATURES



- > Manufactured from a single billet of 316 stainless steel
- > No visible fixings
- > Minimal aesthetic
- > Produces 2 x 120° angles of illumination with an output of up to 64lm
- > Integral anti wicking barrier increases protection against moisture ingress due to incorrect IP rated cable connections
- > Fixing using O-rings and a first fix sleeve
- > Rated IP67 for exterior or interior pathways, staircases and walls
- >  Contains our integral moisture guard (anti-wicking barrier), stopping water ingress from going up the cable into the product from incorrect IP-rated connections
- > Available with Switch, 0-10V, DMX, Dali or Mains dimmable drivers

DIMENSIONS

For fixings and dimensions please go to page 3.



WHITE LED ENGINE SPECIFICATION

Engine	 C1	
Beam angles	120°	
LED manufacturer	NICHIA	
Colour temperature	2200K / 2700K / 3000K / 4000K / 5000K	
Current [Rated Output]	350mA [1.2W]	500mA [1.7W]
Typical LED Circuit wattage	1.1W	1.6W
Delivered lumens (L ₁₀₀)*	50	64
Delivered lm/Circuit W**	46	40
Typical LED Source wattage	1W	1.5W
Source LED lm	133	187
Source lm/W	136	129
Forward voltage (V ₁₀₀)	2.8V	2.9V
CRI	93	
Colour consistency	2 SCDM	
Peak intensity	31 cd	
LOR	0.34	
TM30	RF93 RG98	
UGR rating ('downlight' mounted)	17	18
BUG rating ('uplight' mounted)	B0-U2-G0	
LED lifetime	L90B5 at 90,000hrs	
Applications		

This data is based on an LD65-C1-500-LW27

*LED wattage includes losses associated with using a 90% efficient driver

**Lumen output data applies to all colour temperatures.

MECHANICAL

Ambient temperature	-20° to 50° (350mA-500mA)
Materials	Machine finish 316 stainless steel
IP rating	IP67
Wiring*	Comes pre-wired with 2 core 100mm lead, can be specified with up to 10m at extra cost

ENVIRONMENTAL

TM65	Available on request
TM66	2.6
Repair + Refurbish	 This product is included in our Repair and Refurbish scheme. This offers customers the ability to send back products to us for repair or refurbishment to extend their life without having to buy new fittings.
RLE (REPLACEABLE LIGHT ENGINE)	 Visit page 4 for replacement parts

AVAILABLE FINISHES

Please refer to our finishes guide for full details



316 STAINLESS STEEL

- > Marine grade 316 Steel
- > Standard machined finish
- > Extremely durable with very high corrosion resistance
- > Passivation recommended for marine environments to prevent corrosion and build up of brown stains caused by oxidation
- > Interior & exterior use



POLISHED & PASSIVATED 316 STAINLESS STEEL

- > Marine Grade 316 Steel
- > Mirror like finish
- > Extremely durable with very high corrosion resistance
- > Passivated to extensively prolong resistance to corrosion and brown stains caused by oxidation in marine environments
- > Interior & exterior use



FLAMED SOLID BRONZE

- > Solid Bronze
- > Hand finished Flamed Bronze unique to LightGraphix
- > Extremely durable with very high corrosion resistance.
- > Please note a natural dark patination layer will form after long term exposure to the elements, the extent of this discolouration will be dependant on its location.
- > Interior & exterior use



PAINT FINISH - POWDER COAT

- > White (RAL 9016), Black (RAL 9005), Classic Bronze (YM262E), Gunmetal Grey (RAL 7021), Textured Fir Green (RAL 6009), Textured Mars Bronze, and other RAL colours available
- > Smooth matt texture unless stated otherwise
- > Not recommended for footlights in high traffic areas
- > Interior & exterior use

DIMENSIONS & FIXING OPTIONS

Dimensions in mm

/480 Sleeve and O-rings

Robust, watertight method of fixing for in-ground applications.

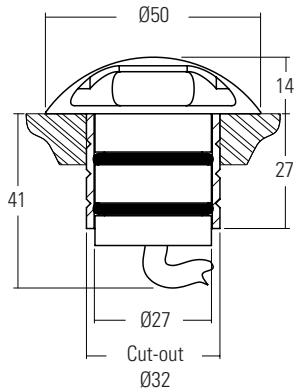

/480GT Ground tube

The in-ground tube has been designed for applications where a recessed uplighter is required in soil or gravel surfaces. The tube can be buried with the necessary wiring, and then the fitting installed after the landscaping work has been completed. It is supplied with the fixing sleeve bonded into the tube, and can be cut down on site.

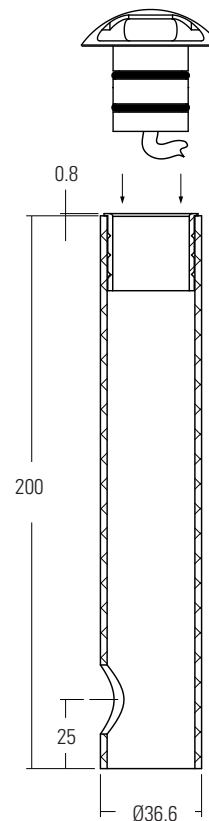

RLE - REPLACEABLE LIGHT ENGINES



What is RLE

On the surface, RLE is LightGraphix's answer to the Circular economy question that is facing many industries at the moment. However for us, RLE is an ethos; a commitment that LightGraphix will factor in the principles of good circular design into all of its future product design. It allows us to offer luminaires that contain replaceable, energy-efficient light engines. This gives customers the ability to refurbish existing lighting installations rather than having to replace the entire luminaire. This will fall into two types of refurbishments: replaceable, and repairable.

RLE Engines

Repairs can be conducted on any site worldwide, or in our factory, with a small tool. Simply swap out the singular modular LED insert, and replace it with another, along with a new optic, which are both supplied by us. The warranty provided with the product varies based on who is performing RLE repairs. There are three types of RLE engine, categorised based on the size of the product. RLE1 is the smallest, with RLE3 being the largest.



Used in the following products:
LD41, LD43DR, LD43DRG, LD44,
LD44G, LD47, LD51, LD56, LD56T,
LD60, LD61, LD62, LD64 & LD65

LD65 RLE REPLACEMENT PARTS

Please use the configurator below to specify your replacement engine and optic. If you are unsure of your original specifications, please check the label on your LightGraphix fitting, or get in touch with our sales team. Installation sheets will be supplied with the new components.

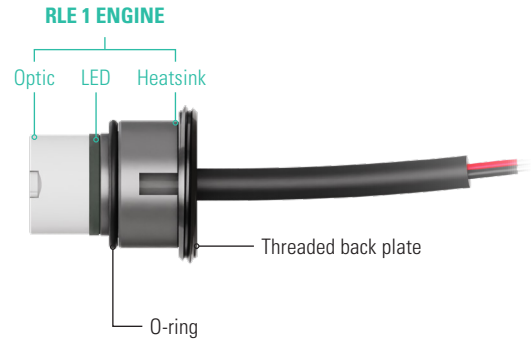

RLE Engine		LED Colour		Optic		Accessories	
RLE1/							
RLE 1 ENGINE	RLE1/	Super Warm White (2200K)	/LW22	Narrow beam 16mm optic	RLE/OP-16/NB	O-ring	RLE/OR2
		Extra Warm White (2700K)	/LW27			Threaded back plate	RLE/TBP
		Warm White (3000K)	/LW30				
		White (4000K) - on request	/LW40				
		Cool White (5000K)	/LW50				

ORDER CODES & OPTIONS

Example: LD65-500 / LW30 / 316 Stainless steel / 480

Light Engine & Drive Current

LED Colour

Finish

Fixing

LD65 - / / /

C1

1.2W LED at 350mA	LD65-C1-350
1.7W LED at 500mA	LD65-C1-500

Super Warm White (2200K)	/LW22
Extra Warm White (2700K)	/LW27
Warm White (3000K)	/LW30
White (4000K) - on request	/LW40
Cool White (5000K)	/LW50
Blue	/LB
Green	/LG
Red	/LR
Amber	/LA

	316 Stainless Steel
	Polished & Passivated 316 Stainless Steel (for marine environments)
	Flamed Solid Bronze
	POWDER COAT White (RAL 9016)
	POWDER COAT Black (RAL 9005)
	POWDER COAT Classic Bronze (YM262E)
	POWDER COAT Gunmetal Grey (RAL 7021)
	POWDER COAT Textured Fir Green (RAL 6009)
	POWDER COAT Textured Mars Bronze
	POWDER COAT RAL

	/480
	/480GT

Drivers
Use with 350mA, 500mA constant current LED drivers
We have a wide range of LED drivers available.
Please see the downloads section of our website.